

THE
MILNER METHOD
OF
DRESSING
CLOTHING

REVISED
EDITION

The PALMER METHOD of Business Writing

A Series of Self-teaching Lessons in Rapid, Plain, Unshaded, Coarse-pen, Muscular Movement Writing for Use in All Schools, Public or Private, Where an Easy and Legible Hand-writing is the Object Sought.

By A. N. PALMER

Late Editor of The American Penman

Revised by the *Palmer Method Department of Handwriting Research* to conform with the Course of Study and Syllabus in Penmanship for Elementary Schools

Published By

The A. N. Palmer Company

New York • Chicago • Cedar Rapids, Iowa • Portland, Oregon

Copyright 1936

B. P.—1403—N. Y.

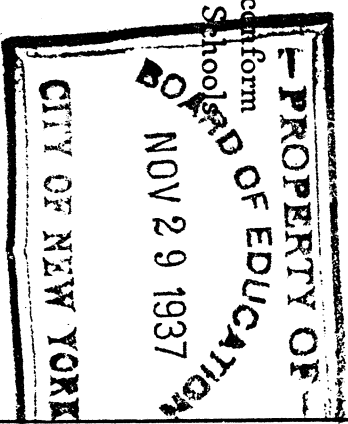

AN EXPLANATION.—The object of this book is to teach rapid, easily-executed, business writing. It has not been written to exploit anyone's skill as a pen artist. It aims to be of use to those who are ambitious to become good, practical business writers. The lessons it contains are not experimental, but have been the means of guiding millions of boys and girls, young men and women to a good business style of writing.

As will be seen at a glance, The Palmer Method of Business Writing has nothing in common with copy-books which have been so largely used in public schools for more than half a century. If they are right, this book is wrong. The two methods of teaching writing are absolutely antagonistic.

In teaching writing, as in other subjects, the final result should be the criterion. Pupils who follow absolutely the Palmer Method plan never fail to become good penmen. On the other hand, no one ever learned to write a good, free, rapid, easy, and legible hand from any copy-book that was ever made.

The copy-book has but one purpose—to secure absolute mechanical accuracy. The copy-book headline is usually first carefully penciled after a given model by a skilled penman, and shows none of the individuality of the penman employed in its construction. The penciled copy is given to a skilled script-engraver, who engraves it by hand and further perfects it wherever possible. This impossible and lifeless ideal the child is required to imitate through long, dreary pages of copying. No wonder he fails!

It has been proved, through at least two generations, that the copy-book kills individuality and makes freedom of movement impossible. It compels slow finger-action in the formation of letters, giving a fair degree of accuracy where only slow writing is required; but the pupil's work inevitably becomes scribbling when the least speed is attempted. In the Palmer Method, freedom of movement is the foundation, and, through a constantly repeated series of rapid drills, the application of movement becomes a fixed habit of the learner. Under this plan the pupil's first attempt is naturally crude, but every drill practiced in strict accord with the printed instructions tends to add grace and accuracy to his work. The sure result is a handwriting that embodies these four essentials—legibility, rapidity, ease, and endurance.

The drills and copies in this book are actual writing, executed with a rapid, easy, muscular movement, and then photographed, thus retaining the individuality of the writer.

Pupils practicing from these lessons acquire the general style of the copies, but, at the same time, there is left to them the possibility of developing their own individuality.

Some Palmer Method Facts

THE PALMER METHOD is a text-book on practical writing and should be studied as such—not treated as a copy-book. The instructions are of more importance than the copies. They tell you how to develop and use the muscular movement in writing. If you do not follow the instructions, you will fail.

Pupils who follow absolutely the Palmer Method plan have always learned to write well. Pupils who have not first studied the plainly printed directions and followed them absolutely have partly or completely failed. Failure is unnecessary.

Thousands of young men and women have made The Palmer Method of Business Writing the stepping-stone to positions in business offices, where commercial advancement rewarded faithful service.

In hundreds of classes where the Palmer Method has been faithfully studied and completely mastered, periods devoted to written spelling, composition, examinations, and other written work have been reduced more than half. Time thus saved has been put to very good use in other directions. In the beginning stages of the work, until good position, muscular relaxation, correct and comfortable penholding, and muscular movement as a habit in writing have been acquired, extra practice may be necessary; but the extra time will be saved many times over in all written work later.

Read and Carefully Consider Everything on These Three Pages Before Beginning the Study and Practice of the Lessons. Failing to Follow These Simple Suggestions, You are Likely to Waste Many Hours, Weeks, and Months in Useless Practice.

Muscular movement writing means good, healthful posture, straight spinal columns, eyes far enough away from the paper for safety, and both shoulders of equal height. These features alone should be sufficient to encourage boys and girls to master a physical training system of writing such as is presented in the following pages, remembering that it is impossible to do good muscular movement writing in twisted, unhealthful positions, or with stiff and rigid muscles.

Straight line and oval drills are of no value except as they lead to writing. They are the means through which to gain the muscular control that will enable pupils to master an ideal permanent style of rapid, plain-as-print writing.

When pupils have learned good posture, correct penholding, and how to use muscular movement in making a good two-space compact oval, they are ready to begin to learn how to write well. Too many pupils think they have really learned how to write well when they are able to make some of the very simple drills in correct posture at the right speed and in correct rhythm. That is really the starting-point toward good penmanship, and should be followed immediately by the practice of words, and, indeed, by the use of the movement in all written work.

Study and practice go hand in hand in securing the best

results in the shortest possible time. Keep the Manual open before you as you practice; study and make frequent and careful comparisons of your work with the drills if you wish to make rapid progress.

Your letters, words, and sentences should occupy the same amount of space they do in the Manual. Always, before beginning practice, the drill should be studied in every little detail until the correct picture is in your mind.

Just how and where does the first line in a letter begin; is it made with an upward or downward stroke; how high is the letter; how wide is each part; how much running space does it occupy; in what direction should the pen move in beginning, continuing, and completing the letter; and at what rate of speed should the letter or word be written? These are questions that should constantly occupy you as soon as automatic muscular movement has been established. In fact, as was said before, study and practice must go hand in hand, if good results are to be the outcome.

Blackboard copies, though written by expert penmen, are seen at many different angles, and at different distances, and do not give correct mental impressions.

It is highly important not only that pupils have copies of the Manual, but that they study the printed instructions and drills, closely and constantly.

The plainly printed instructions in the Palmer Method tell you step by step exactly what to do and how to do it, in order to progress steadily and surely toward the desired end.

Millions of American boys and girls have learned a permanent style of rapid, easy, legible, and beautiful writing by

carefully and patiently following the printed directions found in the Palmer Method of Business Writing. Final results have then been delightful to pupils, teachers, parents, and school officials.

The first step is a correct understanding of the required position. Study the pictures on pages twelve, fourteen, and fifteen, of a pupil who has learned how to sit so as to use the large tireless muscles of his arms to the best possible advantage. Study every little detail of these pictures from the crown of the head to the shoes. Study particularly and closely the arms, the relation of one arm to the other, the position at the desk, the distance of the body from the desk, and the positions of the fingers preparatory to taking the penholder.

As progress is made in the more advanced lessons, you should refer frequently to these pictures and try to sit as this pupil sat when his photographs were taken for the Palmer Method. When writing, he always sits as shown in these photographs, and he knows that it would be physically impossible to use muscular movement writing in a cramped unhealthy position.

There is an old saying, "Practice makes perfect." That is only partly true in relation to writing. Practice of the right kind leads toward perfection, but the wrong kind of practice leads just as surely in the opposite direction. It is not so much the exercise that is practiced as the manner in which it is practiced. Millions of pupils have wasted the time given to movement exercises because they thought it was the exercise that counted and not the manner in which it was made.

There is no value in any penmanship drill ever invented

unless it is practiced with correct positions of body, arms, fingers, penholders, paper, and with exactly the right movement, and at exactly the right rate of speed.

If you study the instructions in the Palmer Method, and follow them absolutely in daily practice, you will make steady progress and, within a short time, become a splendid penman. But, even should you spend a great deal of time practicing the drills in a poor position with cramped muscles and with the wrong movement, you not only will make no progress toward good writing, but will contract bad habits, or firmly fix those already established, and, under such conditions, the possibility of learning to write well will constantly become more and more remote.

It is a fact, that among the thousands of men and women employed in business offices who do longhand writing constantly, rapidly, and well, none can be found who do not use muscular movement, because it is the only movement through which penmanship embracing in the highest degree legibility, rapidity, ease, and endurance can be developed.

It is now generally conceded that systems of copy-books have inevitably resulted in a poor finished product of penmanship. Public school officials and teachers were satisfied with copy-books so long as they did not consider good posture, muscular relaxation, easy, tireless movement and reasonable speed as important factors. Then the discovery was made that pupils were able to draw the letters slowly and very accurately in close imitation of mechanically engraved copies, but that when rapid, continuous writing was required in the pen-

manship employed in written spelling, compositions, examinations, etc., the letter forms became dissipated in appearance and soon approached the stage of scribbling.

It must be conceded by everyone that any system of writing which does not lead to an automatic style embodying legibility, rapidity, ease, and endurance is a failure.

The term "Copy-book" has been applied for many years to sheets of paper bound together with a cover, containing at the top of each page a line of writing or an exercise to be imitated by the pupils on the lines below. Sometimes the headlines are made from carefully penciled copies, mechanically perfected through a system of hand engraving.

There are also bound books, with copies at the top of the pages that were really written with some show of muscular movement and afterward photo-engraved, but the copy-book principles are involved in the publication of such books—principles which preclude the teaching of good writing through their use. The mental attitude of pupils who see before them the immaculate page upon which they must make reproductions, as nearly facsimile as possible of the copies at the top, is wholly unfavorable to the process.

Another recent copy-book system is the pad with the copy at the top, and sometimes at the top and center of each page, there being blank lines below for practice purposes. These modified copy-books are probably doing just as much harm to the cause of practical writing as the former kind. Unless the mental attitude is right, physical conditions will be wrong.

First Specimens

Beginning pupils should write three sets of first specimens on paper about 8x10½ inches. One set should be kept by the teacher, another retained by the pupil, and one set sent to the nearest office of The A. N. Palmer Company.

The value of these first specimens will be clearly apparent as the work of muscular movement development and application progresses and comparisons are made. Those sent to the publication office are alphabetically arranged and kept for future reference. When pupils have mastered the movement and become good business writers, their second specimens should be sent to be filed with the first. The improvement is often so great that the first and second specimens may be engraved and published with great credit to the schools, the pupils, and the Palmer Method.

In these specimens the following form should be followed: On the first line write the name, the age, and the grade; on the second line, the name of the school, city or town, and the date. Skip one line and make a set of capitals; skip a line and make two lines of miscellaneous figures; skip a line and write, "A specimen of my best writing before I began to practice muscular movement writing from the lessons in The Palmer Method of Business Writing." The above was written in..... minutes and..... seconds.

Clothing for the Right Arm

As the muscles of the right forearm play an important part in the movement, it is necessary that they should be so clothed as to permit, at all times, unrestricted action. Many good writers consider this of such importance that they cut off the right undersleeve at the elbow. **To the Teacher:** See that pupils' arms are free of heavy clothing.

Writing Materials

Not much progress can be made with poor paper, poor pens, or poor ink. Good materials are a necessity. Do not use a penholder covered with metal where the fingers rest if another can be procured. Never use an oblique penholder in business writing. It is out of place and of no advantage whatever. Nothing equals an oblique holder for ornamental writing, but there its utility ends. Use paper of generous size for your practice, a medium coarse pen, and ink that flows well. Blue-black writing fluid is the best.

Study the instructions; they are of more importance than the copies

Study These Pictures Closely; It Will Pay

In the first picture, notice that the right elbow rests on or near the lower right corner of the desk. This position may be occasionally modified to suit the needs of pupils. As an example, a very fat boy or girl may find it necessary to let the right arm rest over on the desk a little farther.

A good rule to follow in finding the correct position of the right arm on the desk for writing is as follows: Place the body at the desk in the correct square front position, raise the entire right arm a few inches, and withdrawing control, let it drop. Wherever it strikes the desk it should remain. To draw the arm toward the side would force the right shoulder upward into an uncomfortable, unhealthful position, or would force the pupil to lean backward. On the other hand, to place the right arm farther over on the desk would force the body too far forward.

LESSON 1

Correct Positions for Classroom Writing

IN the following pages are reproduced photographs of a class of students who are experts in the Palmer Method writing. While they knew that their photographs were to be taken, they did not change their every-day penmanship positions in the least particular. It was not necessary, because they had all acquired the habit of sitting in positions that are comfortable and which at the same time permit muscular freedom and control.

In elementary schools in cities, space is so limited that the use of tables or desks large enough to permit the square front position for writing is usually impossible. If the desks are too small for the square front position the half-right side position may be used.

At this point, pupils should be required to close their Manuals and show their familiarity with the preceding discussion of position by answering questions relating to it, and also to assume the position described several times, to prove their working knowledge of it.

To the Teacher:

These photographs show that the pupils sit comfortably in the seats; that the upper ends of their penholders point a little to the right of their right shoulders—usually half way between the elbow and the shoulder; that the Palmer Method is placed at the upper left corner of the desk—being held open at the required drill with a rubber band; that the left forearm is on the desk in such a position as will keep the body upright, the left shoulder from drooping, reserving the free use of the left hand for changing the positions of the Manual and the paper as required.

In this position it is easy to push the sheet of paper forward as progress is made toward the bottom of the page; also to move the paper to the left when the writing has reached a third or half the distance across a line, and back into the first position for a new line.

The exact position of the body at the desk and the relative positions of the left and right arms in writing are very clearly shown in illustration two, while the position of the left arm in its relation to desk, Manual, and paper, is best shown in illustration three.

No student who fails in the matter of position will master muscular movement writing. Correct position is of the greatest importance, and it should be studied and thoroughly mastered before the writing itself is considered.



Position illustration number 1. Read page 7 for instructions.

Lesson 2

Physical Training in Penmanship Practice

Correct Posture, Relaxing Exercises, Movement Practice, and Penholding Taught in Pictures

NO progress can be made in mastering good muscular movement writing until there is a correct understanding of the important steps and the order in which they must be taken.

No written or spoken words can explain these more fully and plainly than the fifteen accompanying pictures given as models. They tell all that could be told about the important beginning steps, and they should be studied with thoroughness now, and often during future practice periods.

Step one, illustration four: Position in seat with arms hanging limply at the sides. **Step two, number five:** Body turned a little to the left and arms extended above the desk, wrists

and fingers limp. **Step three, number six:** After permitting both arms to drop to the desk, raise right arm as shown in the picture, withdraw control and let it drop, repeating the operation until the arm drops comfortably into the writing position, with a square turn at the elbow and fingers bent naturally. **Step four, number seven: Learn to run the writing machine.**

Notice the closed fingers making a fist, and the absorbed interest with which this boy studies his arm near the elbow. The arm is the machine, and the engine that moves it is above the elbow. With the arm lying on the desk in that position, it requires but little effort to drive the wrist forward out of, and to pull it backward into, the sleeve; this is "muscular movement." Fix in your mind the following facts: In muscular movement writing the arm is never raised above, but lies on the desk all the time in a perfectly natural, comfortable position; the sleeve remains in one place on the desk at all times, and the flesh on the arm moves, the action being inside the sleeve.

Careful study of illustrations nine and ten at this point will be helpful. The arrow points to the main rest, which should always be the larger part of the forearm near the elbow. In writing, the wrist and side of the hand should never touch the paper. There are only two rests, the muscle near the elbow, as explained,

and the third and fourth fingers, those fingers supplying a movable rest, and gliding over the paper in the various directions in which the pen moves.

Do not think of writing or penholding at this point, but give all your attention to position, muscular relaxation, and the running of the writing machine, until good position and easy movement have become natural. It often pays primary grade pupils to practice on position, relaxing exercises, and movement, from three to six weeks before taking writing instruments. It is best that all beginners on muscular movement practice should devote several periods to these things before thinking of penholding or writing.

Future progress depends upon present understanding of these first important steps. Even after beginning the movement drills, and when muscular movement is used in all writing, parts of practice periods should be devoted to the study of the writing machine, and to the calisthenic exercises suggested.

Illustration number eight is worthy of close study and imitation. This boy was looking at some object at a distance. In this position you should practice the movement. Test the movement here, and see if you can feel the action of the muscle of the forearm as it rests on the desk.

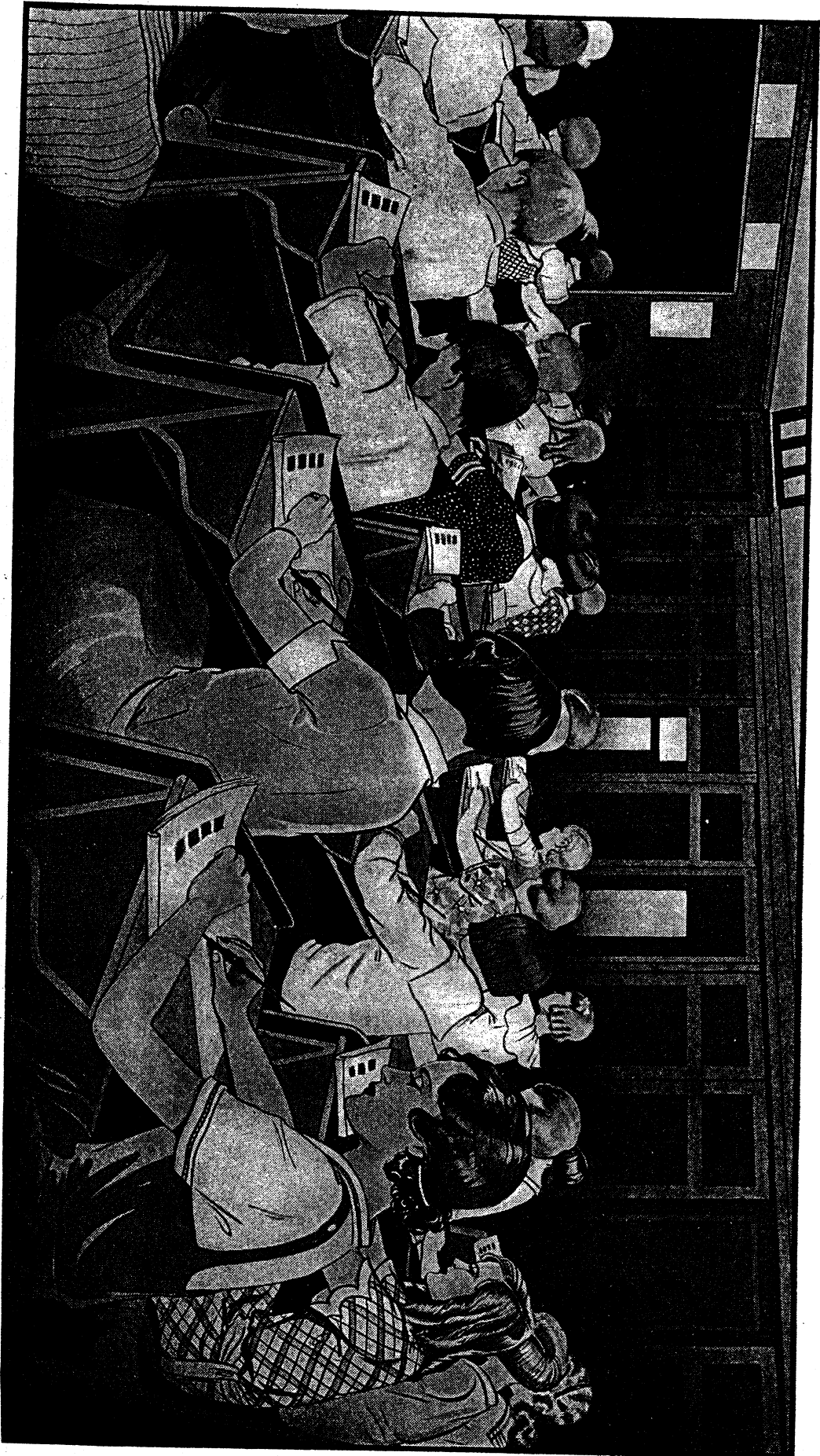

Position illustration number 2. Read page 7 for instructions.

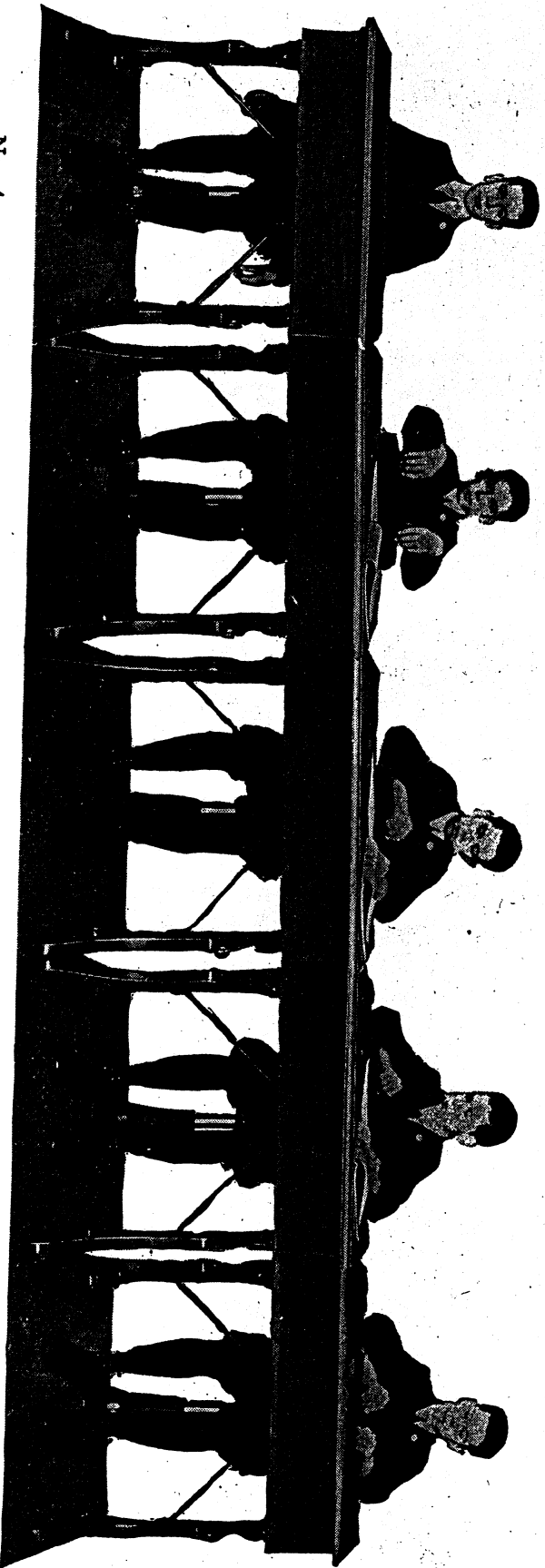

No. 4

No. 5

No. 6

No. 7

No. 8

Definition of Movement

Muscular movement, as applied to writing, is the movement of the muscles of the arm from the shoulder to the wrist, with the larger part of the arm below the elbow on the desk, the fingers not being held rigid, but remaining passive, and neither extended nor contracted in the formation of letters. In this movement the driving power is located above the elbow in the upper muscles of the arm.

Examine your right arm. Notice the increasing size from the wrist to the elbow. Note particularly the elasticity of the muscles. On the

elasticity and development of those muscles depends your success in learning a good style of writing. (Reread this and make sure that you thoroughly understand what muscular movement means before going ahead, because your success depends upon it.)

To the Teacher:

You should again examine your students on lesson one and also on this lesson.

How to Develop Muscular Action

Place your arm on the desk and close the fingers of the right hand tightly. (Number nine.) See how far you can move the hand forward and backward without slipping the sleeve or without any motion of the wrist or fingers.

Can you move that hand through space a sufficient distance to make any capital? Could you make a capital through two or three lines of the paper, two or three times larger than necessary, without any action of the fingers?

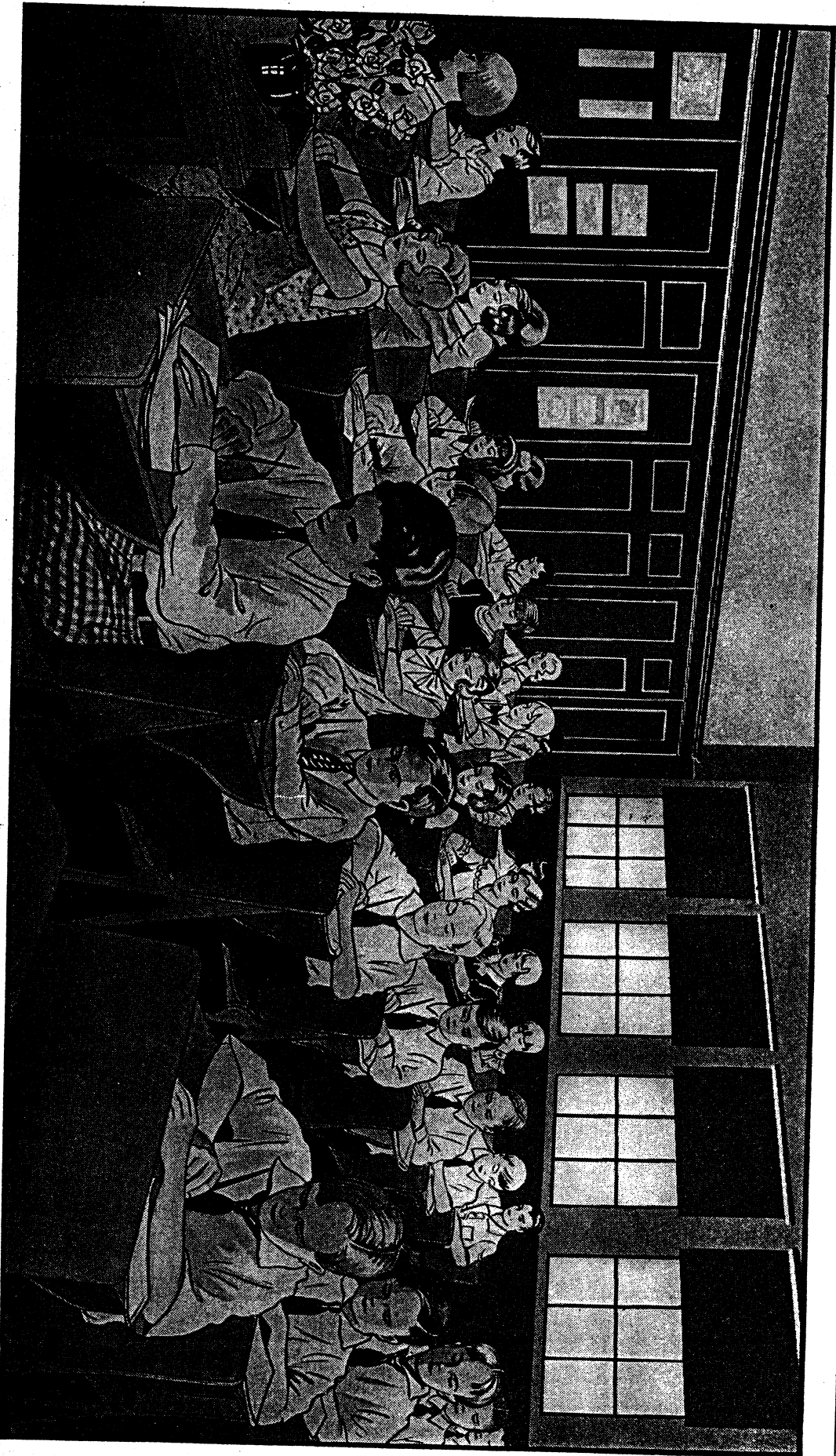

Position illustration number 3. Read page 7 for instructions.

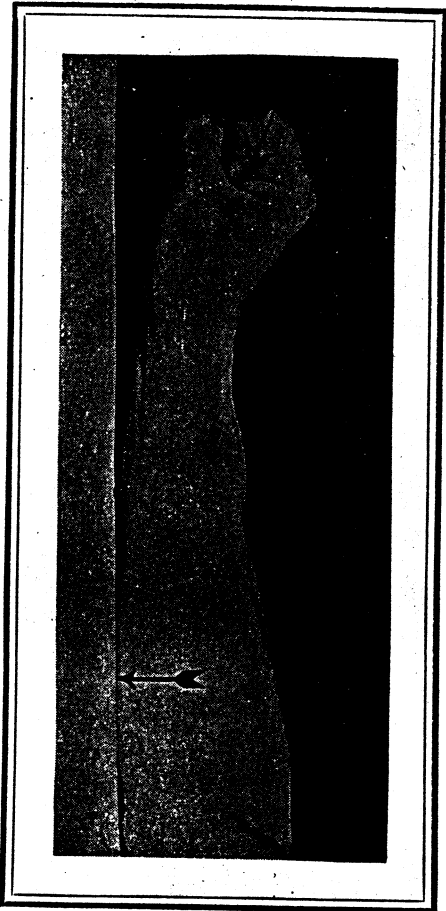

No. 9

ON page fourteen are five pictures of a boy who sits in a splendid position for writing. He is never found in a cramped or poor position. In number eleven, the right elbow is placed on the lower right corner. The arm may then be lowered until it rests in a writing position. In number twelve, the left arm is placed on the desk as shown in pictures one, two, and three, and then the exercise of the muscles begins. The entire right arm is on the desk, and this is the best position, except when the arm is so thin that the bone of the elbow grates on the desk. Then the elbow may be extended off

the desk enough to relieve the discomfort.

In no case will it be necessary to extend the elbow more than an inch; and not one pupil in a hundred will need to take advantage of this exception to the rule, that the entire right arm should be on the desk.

In number thirteen, make a special study of the upper part of the penholder. It does not point toward the right shoulder, and never will, if the arm, wrist, and hand are allowed to retain natural positions, providing pupil and desk are fitted to each other. In number fourteen, again

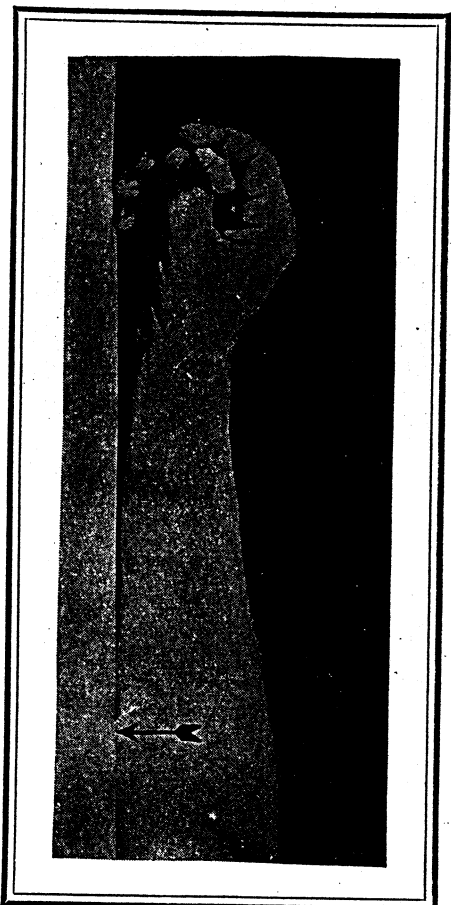

No. 10

study the right arm, and, in particular, notice its distance from the right side, also look at the portion of the penholder in sight.

In number fifteen, notice carefully the distance between the boy and the desk. You should always sit well back in your seat, so far back that the body will not touch the desk. This boy is none too far back; his writing is well in front of the eyes, and it is easy for him to retain the very important square turn at the right elbow. You should follow his good example in the matter of position, and if you practice faithfully you can soon become an expert penman.

Hand, Finger and Penholder Studies

STUDY closely the illustrations on this page. In number 22, the fingers bend naturally as in repose, and their positions should remain the same when the penholder is in the hand.

In numbers twenty-four and twenty-five, you should study the relation of the penholder to the hand. As you see, it is a little below the knuckle joint. The first finger bends naturally, and rests on top of the holder about one inch from the point of the pen; the thumb rests on the holder nearly opposite the first joint of the first finger, and the third and fourth fingers are bent, touching the paper and forming a movable rest. Whether these fingers bend exactly as the illustrations show will depend upon their shape and length. It does not matter whether they rest on the nails or sides, if they are comfortable and can be used easily as the movable rest.

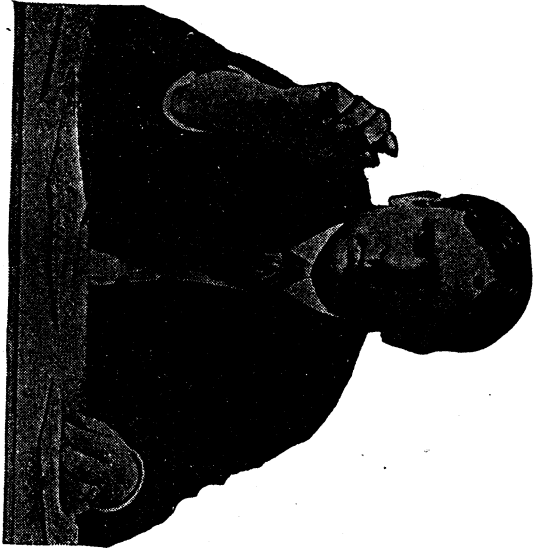

22

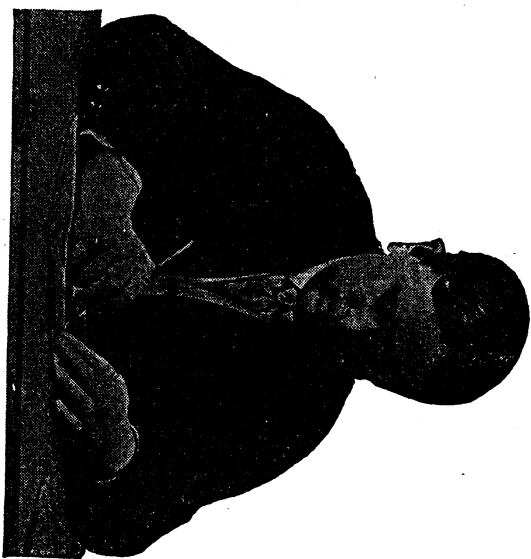

23

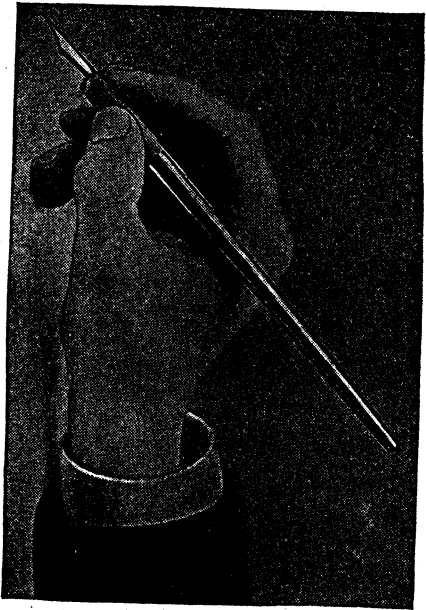

24

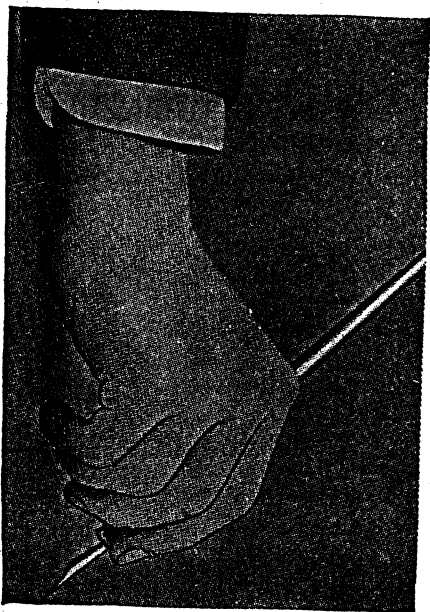

25

Time Required to Learn

The process of learning a good style of muscular movement writing may be made easy or difficult, short or long, possible or impossible, according to the mental attitudes of teacher and pupil, and the exactness with which directions in this Manual are followed.

Pupils who constantly practice the movement drills in poor positions with incorrect movement never even get started, and pupils who practice from fifteen to thirty minutes a day in good positions with correct movement, but who fall back into the old bad cramped positions and finger movement habits in all other writing, do not get beyond the beginning stages, no matter how many years they may practice.

The pupil who becomes the absolute master of a finished style of muscular movement

writing within the limits of six months or one school year is he who gives the closest attention to every detail relating to the beginning steps, who follows the printed instructions closely, who sits in correct position at all times, and uses muscular movement throughout the writing lessons, and in all his written work within a month from the time he begins to study the Palmer Method.

Without conflicting with other subjects it is possible to lay the foundation for an excellent handwriting in one school year, with but fifteen to thirty minutes daily study and practice, and the employment of muscular movement in all written work just as possible. As progress is made in the grades the use of muscular movement can be permanently established.

The boy becomes an expert ball-player by playing ball. At first he is awkward and uncertain, but, as he studies the methods of those who have become experts, and continues to practice, he takes on self-confidence, and

finally develops into an expert, even though he could not hit a single ball during his first few games. Boys and girls who learn to skate with almost consummate grace must pass through the awkward stages, when they sit down instead of standing up as they had planned, and when their feet take possession and run away with them. In instrumental music of any kind one does not become an expert without first learning how to practice and then practicing in exactly the right way according to methods prescribed by master teachers. It is the same in penmanship: first, learn how to practice and then practice faithfully. Acquire elasticity, lightness, and freedom, and do not mind if the pen runs away at first and makes some awkward letters. This is to be expected. But stick to the right plan, and gradually you will gain control of the writing muscles of the arm, and with close attention to general form, size, slant, spacing, and correct movement application, you will become a splendid muscular movement penman in a few short months.

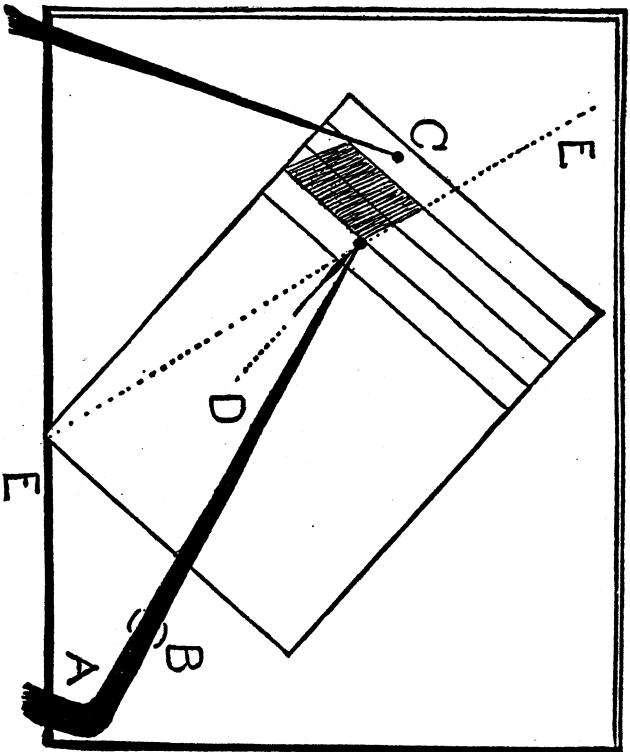

No. 26

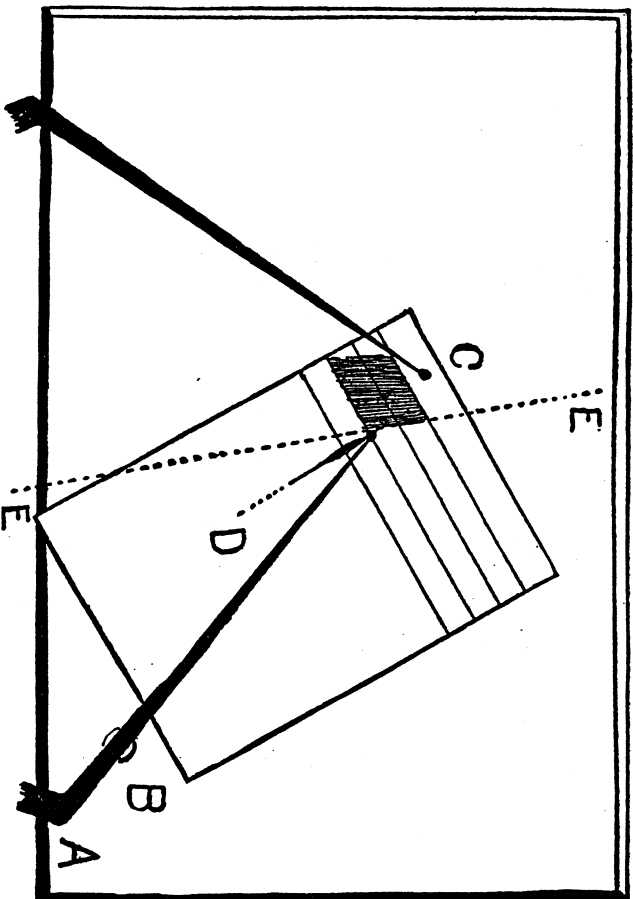

No. 27

THESE diagrams are intended to show clearly the position of the writing paper on the desk, the relative positions of arms, paper and desk, and the direction in which the pen moves to secure uniform slant. Number twenty-six is the half-side position mostly used in public schools and best adapted to them, because of the character of the desks. Number twenty-seven is the square front position.

In both diagrams, A represents the square turn

at the right elbow and its position on the desk, B is the muscular rest of the forearm, C the position of the left hand in its relation to the paper and the right hand, D the penholder, and E E the imaginary line between the eyes along which the pen should travel in upward and downward strokes.

With the right forearm crossing the lower edge of the paper a little to the right of the center, the pen should progress one-fourth or one-third of the

distance across a sheet of paper eight inches wide, before the position of the paper is changed. Always use the left hand to move the paper. Paper $8 \times 10\frac{1}{2}$ inches in size should be moved three or four times in the progress of the pen across it. When the end of the line has been reached, the paper should be returned to its original position, and should be moved up on the desk the width of one line. Lift the pen before moving the paper.

It is not Palmer Method if the lines are tremulous. Study instructions for speed requirements

LESSON 4

Now the serious work of using and applying the correct movement begins. Before attempting to make any part of drill one, review lessons one, two, and three, and give the closest possible attention to position,

muscular relaxation, and penholding. Don't practice before you know how. With the left hand, move the paper to the left three times at equal intervals, in the progress of the pen across it.

Drill 1

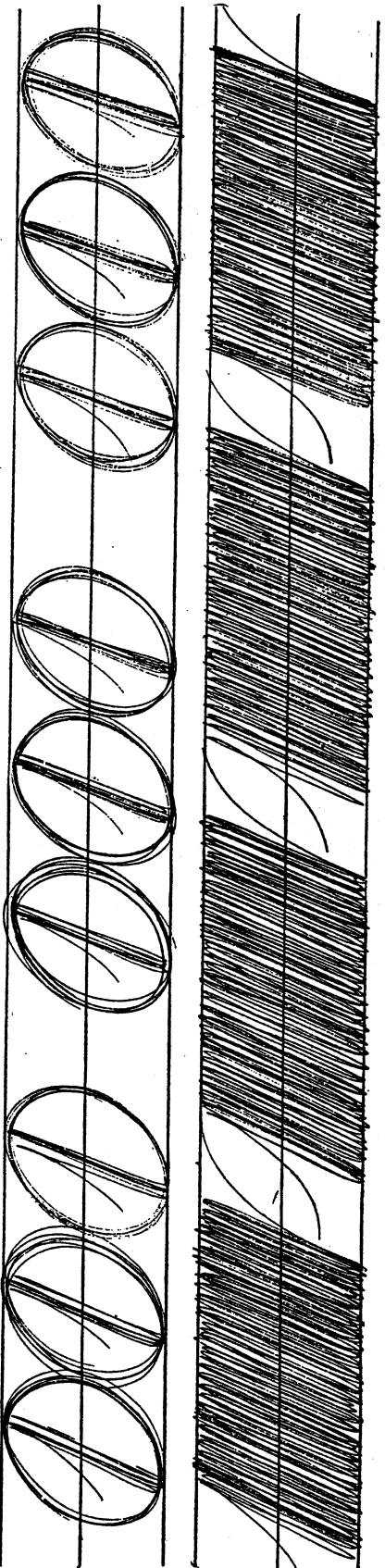

Letting the distance between the two ruled lines, three-eighths of an inch apart, represent one space in height, any part of this drill should be two spaces high. Look at these drills until you have a good mental picture of the height, proportions, and general appearance.

In connection with the straight line part of the drill, study closely diagrams twenty-six and twenty-seven on page eighteen. There is no value in this straight line exercise unless practiced with a forward and backward motion, from and toward the center of the body, with the paper held in the correct position.

If you cannot make the several parts of drill one high enough at first with pure muscular movement, practice without touching the pen to the paper until you have developed more muscular freedom.

In the second line of drill one, the traced oval should first contain six,

and later, as a lighter movement is developed, ten revolutions. In this drill it will be well to make first the straight line on the correct slant, and then the oval enclosing it. This order may be changed frequently and the ovals made first. This is an important drill as it has a very specific bearing upon slant.

To the Teacher: It may be profitable for third, fourth, and fifth year pupils to spend the practice periods of one week in studying and practicing the two movement drills given in this lesson, reviewing each day everything that has gone before. Pupils in the sixth, seventh, and eighth years, and in high school classes should be able to progress more rapidly. It is not safe to say how rapidly, as that depends upon the knowledge of the teacher, the mental caliber of the pupils, their interest in the work, the length of the daily lessons, and the amount of the right kind of outside practicing that pupils do.

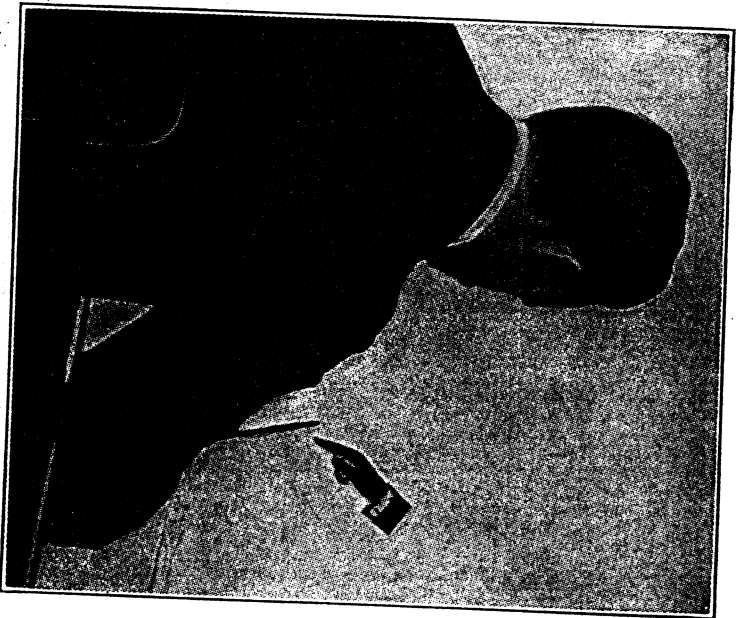

No. 28

Study the accompanying illustration, number twenty-eight. Notice the direction in which the upper part of the penholder points, the distance between the elbow and the side, the self-supporting position of the body in the chair, and the distance of the eyes from the paper. Do not forget that the force that moves the hand and carries the pen along without bending the fingers is

above the elbow. It is not located in the fingers, hand, wrist, or forearm.

The fingers hold the pen easily and firmly without pinching; the third and fourth fingers are bent backward and form the movable rest under the hand; neither the wrist nor side of the hand touches the paper, and the arm should rest all the time on the largest portion in front of and near the elbow.

If the paper you are using has lines eight inches long, divide the page in the center from left to right with a dot; then divide the halves in the center with other dots. Beginning at the left for the straight line drill, make one hundred downward strokes to the first quarter mark, and continue in the same manner for each quarter. Thus, four hundred downward strokes and, of course, an equal number of upward strokes should be made in the four sections extending across a line. See drill one; page nineteen.

Counting to Regulate Motion

In developing light, uniform motion in class penmanship practice, counting is important. It makes the work more interesting, tones down the movement of the naturally nervous pupil, acts as a constant spur to the habitually slow boy or girl, and keeps the indolent student busy. In the oblique straight line and the oval exercises given in drill one, the downward strokes only should be counted. The other parts of the drills, being what are termed connective lines, are not counted.

About Speed

Speed is so important in the development of good writing that it should receive close attention in all practice work until correct speed has become a habit. Too much speed is just as bad as too little. Correct speed forces a light, firm line; too little speed results in shaky tremulous lines; while excessive speed means irregular letter formation. If you develop a light, firm, elastic motion, and the proper degree of speed in straight line and oval making, you will find the work of the following lessons comparatively easy.

The straight line and oval exercises in drills one, two, and three should be made at a speed of two hundred downward strokes to a minute; one hundred in one-half a minute; and then move the paper.

The most convenient count for continuous straight line or oval exercises as given in drill two is 1, 2, 3, 4, 5, 6, 7, 8, 9, 10—1, 2, 3, 4, 5, 6, 7, 8, 9, 20—1, 2, 3, 4, 5, 6, 7, 8, 9, 30—1, 2, 3, 4, 5, 6, 7, 8, 9, 40—1, 2, 3, 4, 5, 6, 7, 8, 9, 50, continuing until two hundred has been reached. Until correct speed habits have been developed, the second hand of a watch should be used as a guide.

A few minutes in the right way are worth more than hours of practice in the wrong way.

LESSON 5 — Drill 2

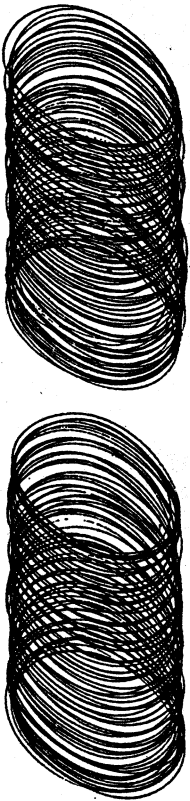

Count 100 for each of the two sections of drill 2. Time: 30 seconds for each section.

Teachers: To develop light, uniform movement in class penmanship correct counting is important, and should be actually timed by a watch. Alternating from concert, individual and silent count is interesting. The teacher's count will help to stimulate the slow pupils and check the rapid students. An occasional change from the numerical to descriptive or

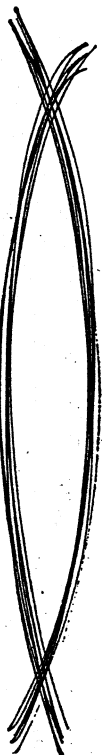

1. The over curve

2. The under curve

3. The slide between letters; as,



4. The slide between words; as,



corrective count will be found helpful.

The purpose of exercises 1 and 2 is to help in giving the pupil the *idea* of the side-to-side progression.

The purpose of exercises 3 and 4 is to help in establishing the *habit* of easy side-to-side progression while letters are being formed.

ABOUT SLANT

Slant needs no special study, but will take care of itself if the instructions have been studied and heeded. Especially is this true in relation to the position at the desk, the position of the paper and arms on the desk, the relation of each to the other, and the changing of the paper with the left hand, to keep it in the right position in regard to the desk, body, and arms. See diagrams—page eighteen.

If the position is correct, and if all downward strokes are made

toward the center of the body, each pupil will develop uniform slant, though different pupils may develop individual slants. Following the same rules, and practicing at the same time under similar conditions, different slants result, because of the variations in length of arms, and other physical conditions. The degree of slant is not a matter of grave importance so long as each writer develops uniform slant in his own writing.

In drill two, see how many compact ovals you can make with one dip of ink, and try to develop a motion so light and elastic that you will soon be able to make from five hundred to a thousand, and one thousand or more on a line eight inches long.

Many young pupils have developed such control of muscular movement that they have made more than two thousand ovals with one dip of ink, in a space not more than eight inches long. Indeed, one boy of twelve made three thousand within the limits of a page eight inches across, maintaining a uniform speed of two hundred to a minute. The pen used was of the ordinary large, business variety.

Skill in oval making should be developed gradually from day to day, as two or three minutes at the beginning of each practice period are devoted to ovals. Never make ovals on the "back slant." Avoid this by pulling the strokes toward the center of the body.

Lesson 6

Each practice period should begin with a review of position, careful study of the arm, fingers, and penholding, and practice of the preceding movements, without touching the pen to the paper. While going through these preliminary drills, the eyes should travel up and down the arm

from finger-tips to elbow, and the pupils should be sure that the writing machine has been carefully adjusted, and is in perfect working order before the pen touches the paper. See that the arm is perfectly relaxed and that the wrist does not touch the desk.

Preparatory Motion

Read the following carefully until thoroughly understood. It is of especial value to beginners. Before making the oval drill or attempting any part of it, move the pen in the air rapidly over the path of the first oval several times. While doing this, watch closely the movement of the muscles of the arm. While the pen is moving rapidly, and without checking its motion, let it strike the paper. The force thus gathered will compel light, quick action, break up finger motion, give smooth lines, and aid form building.

Form Building

The compact oval is the repeated form of a large capital O. Keep this constantly in mind, and learn at once to criticize it with special reference to the slant, width, and general formation of a capital O a little more than twice the size used in writing.

Mind and muscle must work in perfect harmony to secure the best results.

Before beginning the practice of any drill or letter, study its form closely, part by part, and as a complete whole. In what direction does the pen move to make the first line? See that the pen moves in that direction before coming in contact with the paper. Be sure that the speed is neither too fast nor too slow, but such as will make two hundred complete ovals to a minute. Do not guess about the speed, but use a watch.

If the oval is too wide, it is because of too nearly circular motion, and you should use more of the forward and backward motion of the straight line exercise. If too narrow, it is because too much of the straight line motion was used, and the movement should be more nearly circular. Remember the connection between mind, muscle, and motion.

When the oval is too narrow, repeat to yourself, "Wider, wider, rounder, rounder, rounder, rounder," until it is wide enough. If the oval presents a back slant appearance when finished, it is because the downward strokes were made toward the right elbow instead of the center of the body.

On the other hand, if the oval slants too much, it is because the downward strokes were made toward the left shoulder instead of the center of the body—always providing that instructions relating to position have been strictly followed.

Drill 3

all on and will be by you
five gh with us by we on own

one

two

into

oval

noon

matter

some

ocean

room

here

round

Spain

corn

home

day

When pupils make the ovals fairly well, they are ready to begin to apply muscular movement to words and sentences. The letters in the word "as" (called minimum letters) are about one-twelfth as high, or one-sixteenth of an inch. The speed should be such as will permit good formation, and produce sharp, clear-cut lines.

Good practice speed for these words is "noon," eighteen; "into," twenty; and "some," twenty-two, to the minute. These words should be

practised now until they can be written well, and should be reviewed frequently. Practising them at this stage with muscular movement will give students confidence and should encourage them to use, constantly, muscular movement in all written work. Other easy words may be selected from the Manual and practised occasionally. It is a distinct advantage to study frequently at this stage lessons 15, 16, 17, 19, 20, and 32, and to practise drills 13, 14, 15, 17, 18, and 33.

The Palmer Method

LESSON 7 — Drill 4

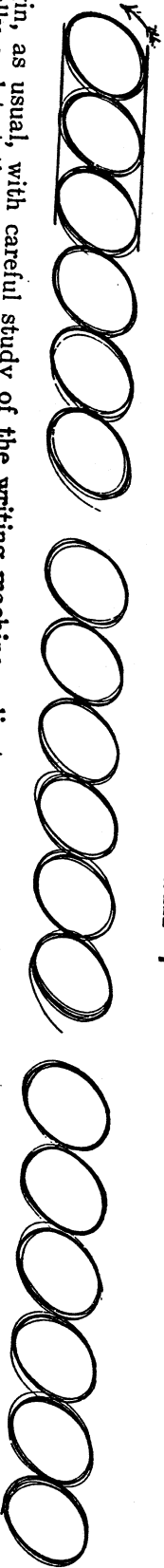

Begin, as usual, with careful study of the writing machine, adjust it carefully and test the movement. Then practice the two-space compact oval in drill three.

In drill four the special object is to develop a uniform, continuous motion. Preparatory to the first oval, the movement should be tested by carrying the pen rapidly in the air, the arm resting, and the hand in a good writing position. Without checking the motion, the pen should be brought to the paper, thus forcing it to make sharp, clean-cut lines. In passing from one oval to another, the pen should be lifted from the

paper at the base line without checking the motion, should swing below the base line to the right and to the beginning of the next oval, a uniform speed being maintained throughout. Thus, the motion is continuous and no shaky lines are possible. Finish the final oval in each group with an upward right curve as shown in the drill. Move the paper with the left hand after each group of six. Pupils should study the above instructions in connection with the oval practice until fully understood. These instructions are important, having a direct bearing upon the practice of capital letters.

Drill 5

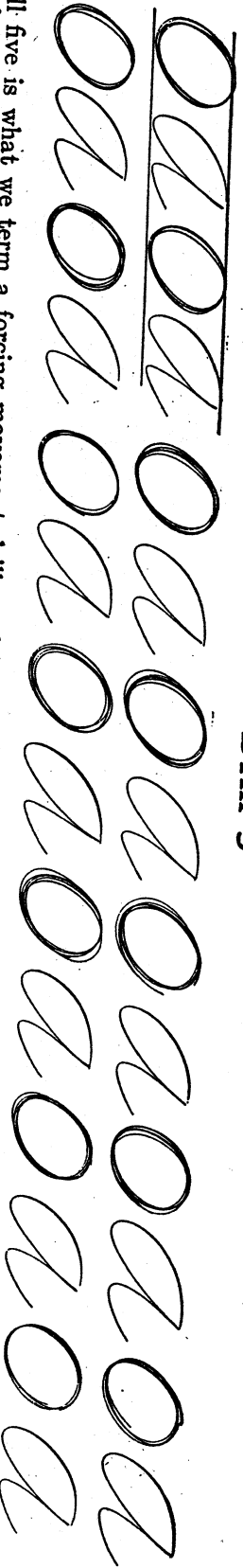

Drill five is what we term a forcing movement drill, and is one of the best for the beginner to practice.

In the direct traced oval make six revolutions to a count of "1, 2, 3, 4, 5, 6," lifting the pen at the base line on the sixth count without checking the motion and swinging it in the air to the beginning stroke of the capital A. Thus the pupil will be impelled from a slow, lagging movement to one that is elastic and rapid. The form may not be entirely

satisfactory at first, but it will improve rapidly if this process is continued long enough and frequently repeated. The rate of speed should be about twenty complete traced ovals, and as many capitals to the minute. Before beginning to practice, count the ovals and letters. There are seven of each. You are expected to make the same number on a line of equal length.

LESSON 8—Drill 6

Assume correct position; practice the movement without, and then with, the penholder. Be sure that you are using exactly the right movement.

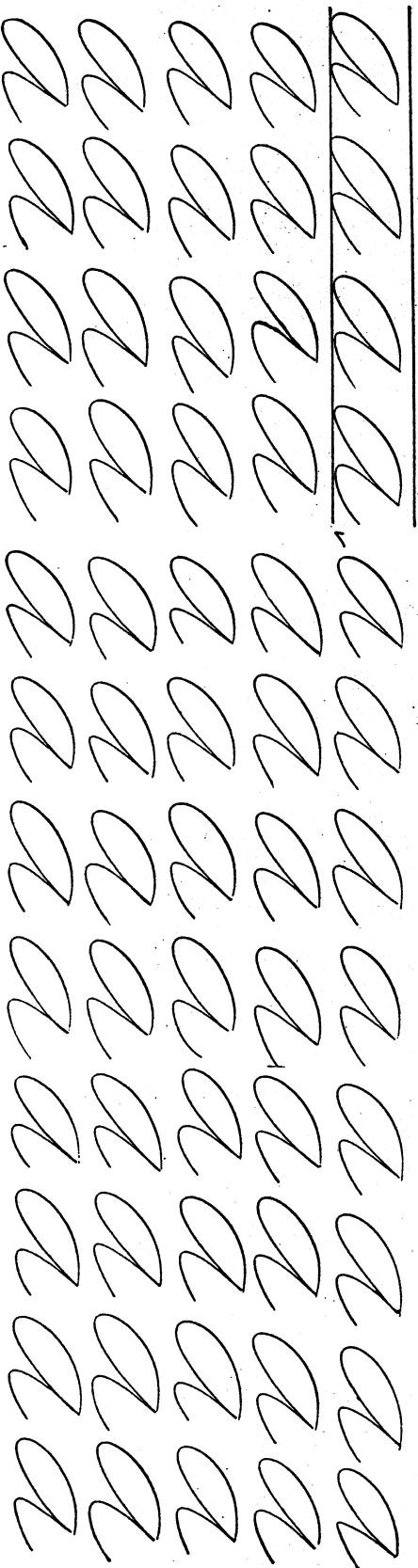

When two lines are connected in an angle, a positive stop at the point of connection is necessary. This principle applies to the top of capital A where the upward and the last downward strokes are joined. This stop is such a small fraction of a second in duration that it can hardly be detected. Without the stop at the top of capital A, a loop will be made. To emphasize this stop in connection with capital A, the following conversational count has been developed. "You stop, you stop, at the top, you stop, every time, at the top. How long do you stop at the top? Not long, but you stop, every time, at the top. What for, what for, what for? Oh! To close them up, to close them up, to close them up," and repeat. Other conversational counts that may be used with capital A are, "Roll the arm, on the muscle; see it roll, on the muscle; slide the hand, on the fingers, see them slide, over the paper, make them glide." Make your letters the same size as in the drill, and begin each letter as the pen moves downward. Make capital A in groups of four, and move the paper a little to the left after each of the first two groups

as indicated by the check mark. When the third group of four has been finished, move the paper to the right to its correct position for beginning a line. Learning to move the paper in this and in other drills is very important. There are three groups of four, making twelve letters to a line in drill six, and five lines, sixty letters, should be made in a minute. A count of eight should be used in each group of four, and the count for each group should be 1-2, 3-4, 5-6, 7-8, move the paper, 1-2, 3-4, 5-6, 7-8, move the paper, 1-2, 3-4, 5-6, 7-8, move the paper. In beginning every practice period hereafter, your program should be the two-space compact oval, one minute—two hundred ovals, and capital A, at a speed that will produce at least sixty-five and very soon seventy-five in a minute. For the present, three minutes could very profitably be spent in repeating the capital A with an easy, swinging, rhythmic motion. Select your best capital and compare it with the models giving close attention to size, slant, width, distance between letters, and the beginning and finishing lines.

If muscular movement is taught to pupils of the first and second year primary classes according to the Palmer Method plan, they will enter the third year of their school life well prepared to use the movement in all their writing. If pupils in classes from the third to the eighth year inclusive have

LESSON 9—Drill 7

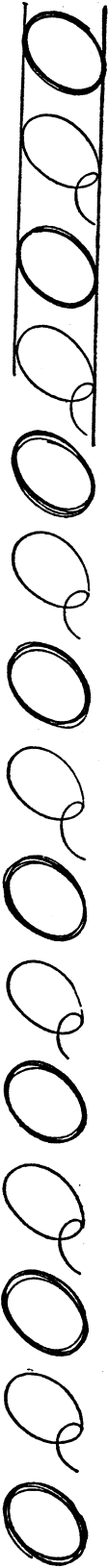

Do not neglect the compact oval practice; one line across the paper will no doubt be enough if very compact.

The method of practice in drill seven should be the same as in capital A, drill five. After each traced oval, lift the pen while in motion, swinging it

copies of this Manual, study it closely, and follow it absolutely in daily practice under teachers who have mastered the lessons before attempting to teach them, rapid improvement will be evident from week to week, and the ideal in rapid, easy, legible writing will soon be attained.

below the base line and around to the beginning point of capital O without checking it. Drive the pen rapidly and bring the muscles of the arm into active play. First make ten revolutions for the traced oval, gradually decreasing the number to six; count six for the ovals and two for each capital O.

Drill 8

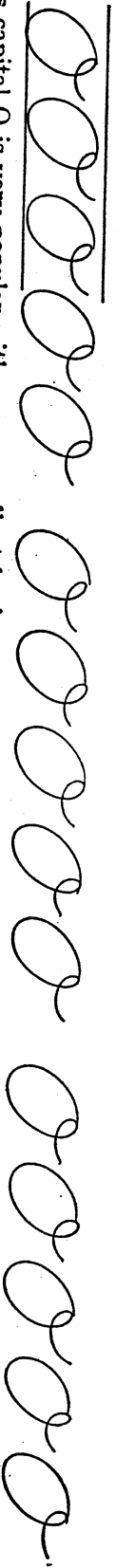

This capital O is very popular with many excellent business penmen and teachers of modern writing. Study the letter and make a mental photograph of it. Note particularly the curves of the left and the right sides; also the loop at the top, its general direction and size.

In finishing O the final stroke should be pushed upward. If it is pulled downward it will too nearly resemble A. Capital O should be made at the rate of seventy or more to a minute. Count 1-2 for each O.

LESSON 10

Devote the time of this lesson to a general review of the preceding lessons.

LESSON 11—Drill 9

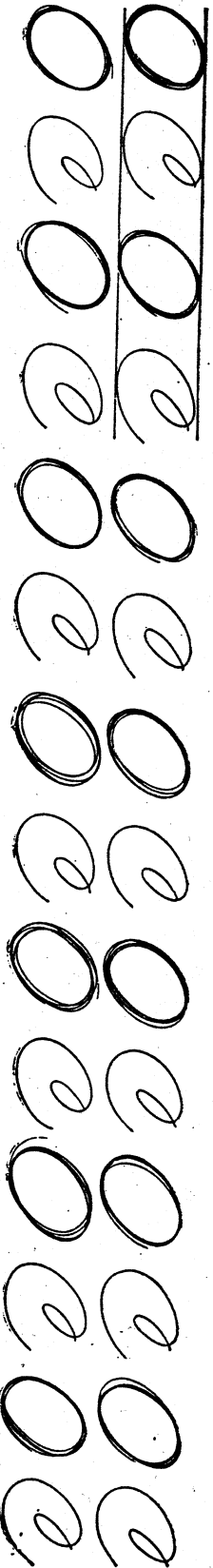

The plan of practice for drill nine should be the same as for drills five and seven. The count should be 1, 2, 3, 4, 5, 6,—1, 2, and repeat. No matter what may precede capital C, when the pen comes in contact with the paper in the beginning line it must move downward in the direction of a left curve.

Drill 10

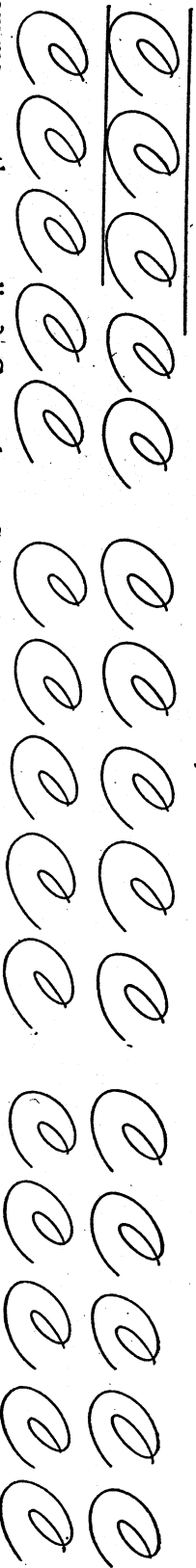

How many are there on a line? Count them. Swing the pen in the path of a C several times before making the first letter; in fact, aim before you shoot. Lift the pen from the paper while in motion in finishing a capital; continue the motion with the pen in the air and bring it to the paper to begin the next capital—all without checking the motion. Make about seventy letters to the minute. Count 1-2 for each C.

LESSON 12—Drill 11

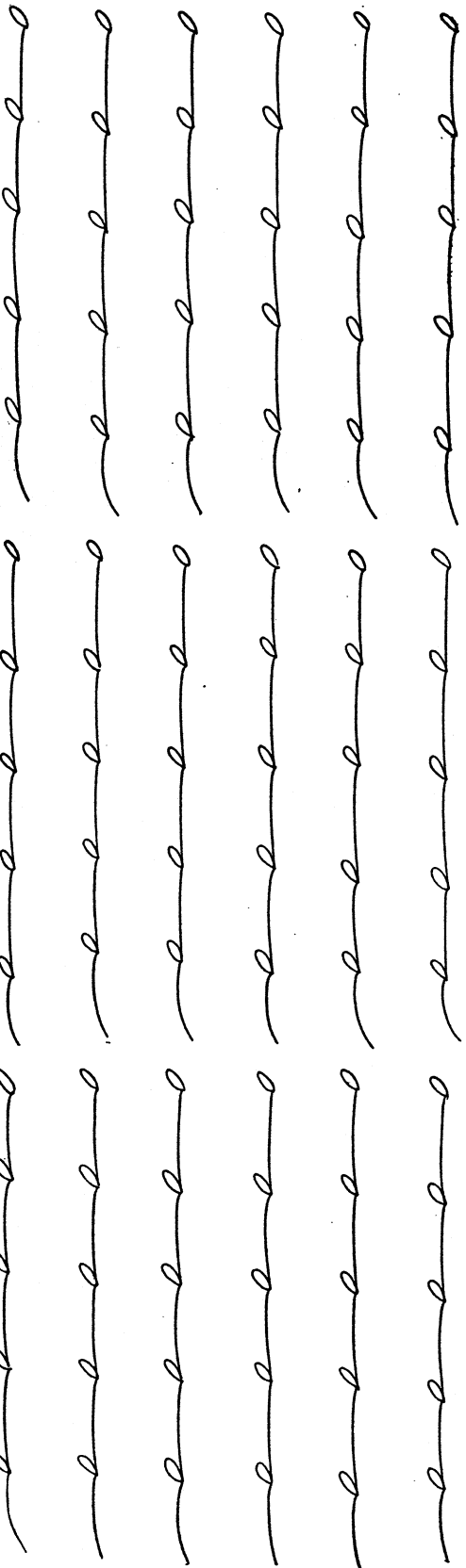

See instructions for drill eleven on following page.

Hereafter, each lesson should begin with practice of the compact two-space oval, drill three, drill six, and drill eleven, and there should be frequent reviews of the other drills so far practiced.

In the large oval drill and its modifications in capitals A, O, and C, the motion has been mainly forward and backward, while that used in the connected small o drill is mainly toward the right, developing the lateral movement. If too much driving force from above the elbow is used, the letter will be too large. If the position is just right, the least possible force will drive the hand far enough to form the o. The line connecting the letters should be as nearly straight as is possible to make it at the required speed. If too pronounced an under-curve is used in the connective lines the result will be a form more nearly resembling small a than o.

In this style of writing, small o and letters in its class should be one-sixteenth of an inch high. The letter in this drill is of that height, and it should be used as a basis of comparison in determining the height of the other minimum letters a, c, e, i, m, n, r, s, u, v, w, and x. Small r and s may be made one-fourth higher than the other letters in the minimum class.

Wherever there is an angular connection as in closing small o at the top, there must be a checking of the motion at that point; in fact, a stop. The closing of o is so quickly done that the stop can hardly be seen even by the closest observer.

To the Teacher: In connection with this drill we urge teachers to use a conversational count. In passing from desk to desk, criticise the

work in correct rhythm. Suppose one student is making o too large, another not closing it at the top, another using a slow, dragging movement, another making a narrow, flat letter, and still another bending over his desk too far. The criticisms would be as follows: "Make it smaller, make it smaller; close it up, close it up; you stop, at the top, you stop, every time, at the top. How long? Not long; but you stop, every time, at the top. Slide along, slide along; round o, round o; sit up, sit up." Each criticism or admonition may be repeated until the error has in a measure been corrected. The influence will not be lost upon the rest of the pupils, but those who have been making the same errors will almost unconsciously show marked improvement.

A speed of ninety or more to a minute should be developed and maintained. Ninety in a minute is by no means fast, but, while permitting good form, it is fast enough to force light motion.

In drill eleven, there are three groups of five letters in a line, and there are six lines in the drill, making ninety letters. These should be made in a minute, and that should be the practice speed. As in capital A, the plan is to make each group to a count of ten, and then move the paper. For an entire line the count would be 1-2, 3-4, 5-6, 7-8, 9-10, move the paper, 1-2, 3-4, 5-6, 7-8, 9-10, move the paper, 1-2, 3-4, 5-6, 7-8, 9-10, move the paper. The conversational count may be fitted nicely to the rhythm of the count of ten. Hereafter, drill eleven should be practiced with the two-space compact oval, and drill six at the beginning of each practice period.

**The Palmer Method is a textbook on practical writing.
The instructions should be studied and followed.**

LESSON 13

Make this a general review lesson.

A B C D E F G H I J K L M
N O P Q R S T U V W X Y Z
a b c d e f g h i j k l m n o p
q r s t u v w x y z 1 2 3 4 5 6 7 8 9 0

SPECIAL STUDIES OF THE CAPITALS, SMALL LETTERS, AND FIGURES

Pupils who have studied and followed the explanations, suggestions, and instructions so far will have sufficient control of the muscular movement to master easily the letters on this page.

Those who have not been thorough in studying the instructions and practising the drills should review. Nothing less than failure can follow superficial study.

The capitals, small letters, and figures are given at this point for

convenient reference, and an effort should be made hereafter to employ these forms in all the written work.

One lesson each week should be devoted to special study and practise of the capitals until they are mastered.

Capitals, small letters, and figures will all be taught thoroughly in the following lessons.

A few minutes in the right way are worth more than hours of practise in the wrong way.

★

LESSON 14—Drill 12

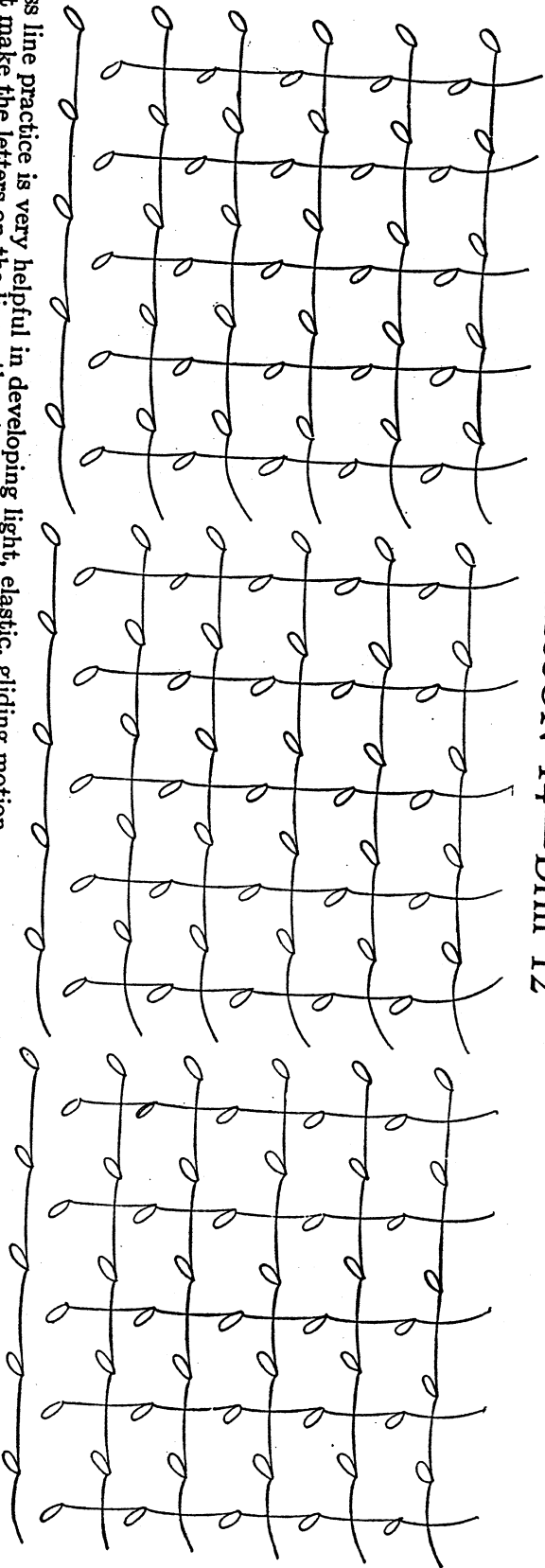

Cross line practice is very helpful in developing light, elastic, gliding motion. First make the letters on the lines; then turn the paper and make them across.

LESSON 15

MORE ABOUT COUNTING

In writing, as in music, regularity of movement is an important factor. A jerky, spasmodic motion is to be avoided and successful teachers of writing have found that some method to mark the time of making parts of letters is helpful. Some use a metronome, some a chalk box and a ruler, others musical instruments; but we prefer that wonderful machine, the human voice, and a process of counting to fit the letters. In individual home practice the counting process is of as much value as in the school-room, and pupils should learn to use it.

When a letter is poorly made, it may be due to one or all of four causes—first, the position may be poor; second, the muscles may be rigid,

preventing easy action; third, the mind may not have a good picture of the form; and fourth, movement direction may be wrong. As an example, when small m and n are made too sharp at the top, it is because there is not enough over-motion.

The special object of drill thirteen is to develop the over-motion for m and n. As you practice this drill, count 1, 2, 3, 4, 5, 6, 7, 8, 9, 10, for each section, or use a verbal count as follows: Over, over, over, over, over, light, light, light, light, light. In the first line the exercise should occupy one-half the space between ruled lines; and in the second, the height should be the same as small o, one-sixteenth of an inch.

Drill 13

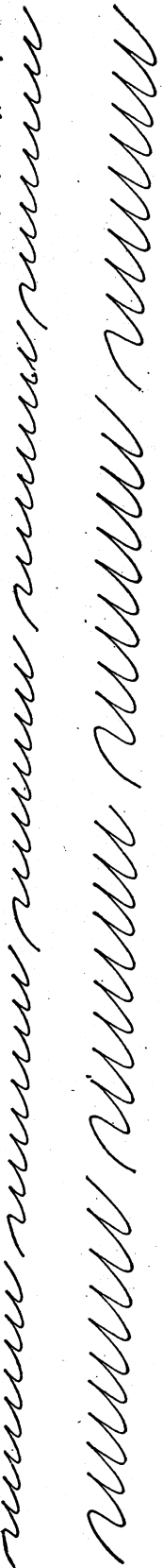

Remember that the larger part of the right arm just in front of the elbow, should rest on the desk, and the third and fourth fingers of the right hand be bent well under; that the position of the pen in the hand must be comfortable and the right arm well out from the side. Now

push the hand forward and backward to test the freedom and movement power. If the muscles move easily, let the pen touch the paper, moving lightly and rapidly. About fourteen completed sections of the first line should be made in a minute and sixteen of the second.

LESSON 16—Drill 14

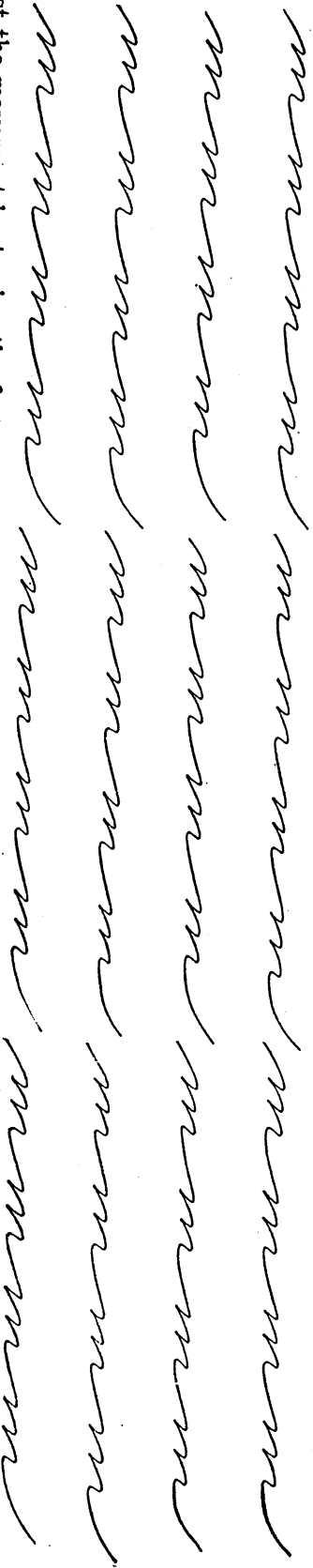

Test the movement by tracing the first stroke in the air. Start the motion below the base line, and as the pen moves rapidly upward let it strike the paper at the beginning point. Drive the pen through the exercise rapidly and lightly. Make four connected m's before lifting the pen, and three such groups across a line. You will make the letters too large, irregular, and awkward at first, and will have trouble with the union (connecting lines), but keep right on. Make the four lines in a minute and move the paper after each group. As taught in drill thirteen, lesson fifteen, the parts of small m are made with over-motion, but to use an over-motion between letters would give no connective line and hence no dividing line between the letters. Keep in mind as you practice, that the

over-motion makes the parts of m, and that the opposite or under-motion forms the connecting lines. You may count 1, 2, 3; or slide, 2, 3; or over, under. Drill fourteen should be practiced a minute or more at the beginning of each practice period. Four drills have now been suggested for use at the beginning of every practice period. They should be practiced, not only in the beginning stages, but until the entire course has been mastered. These drills furnish the very best movement exercises, and at the same time give the right kind of practice in form building. Students who thoroughly master them in size, form, and speed application will find the remaining drills easy. As it teaches the correct use of the under-motion in connecting letters, small m is perhaps the most important of the four.

LESSON 17

From this point each lesson should start with the compact two-space oval; drill eleven, small o; and drill fourteen, small m. It will pay to devote from three to five minutes of each practice period to these three drills.

Drill 15



For small m, a count of three is used; and in n, a count of two. Thus, the count for drill fifteen will be 1, 2, 1, 2, 1, 2, 1, 2, etc., or for five connected letters, 1-2, 3-4, 5-6, 7-8, 9-10. The speed should be the same relatively as in the small m drill.

LESSON 18—Drill 16

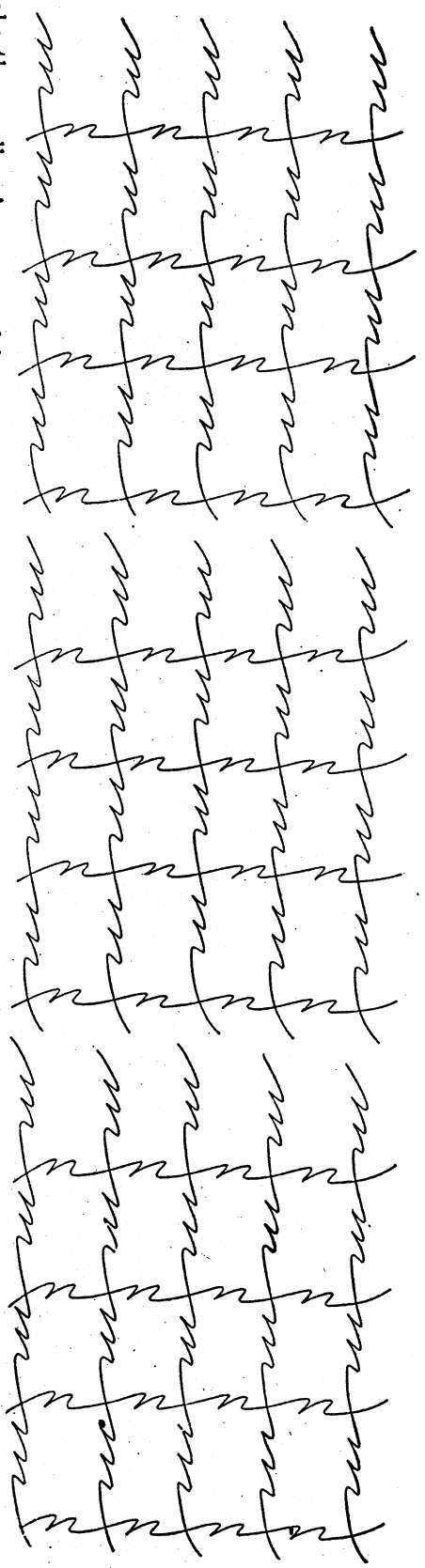

Make the small m in groups of four, three groups to a line, and five or more rows; then turn the paper and make groups of small n. Make frequent comparisons with the drill as you practice.

LESSON 19—Drill 17



Small *i*, being made entirely with an under-motion, has a sharp point at the top. Count 1, 2, 3, 4, 5, for each group; make the downward as light as the upward strokes and try to make them equal distances apart. Make five groups to a line and fifty letters to a minute.

Drill 18



A space in width is the distance between the points of small *u*. This is sometimes called a lateral space. For each group of four connected letters, count 1-2, 3-4, 5-6, 7-8.

Drill 19

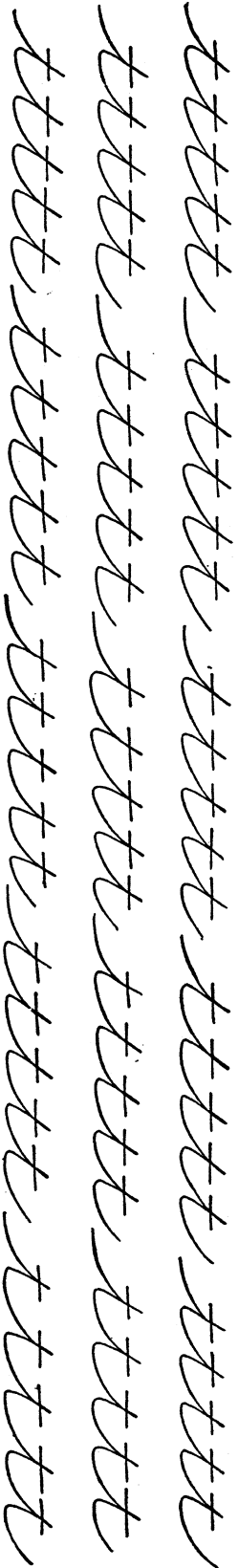

Extend small *i* about two and one-half times its height, cross with a short horizontal line, and the result will be small *t*. An effort should be made to bring the upward and downward strokes of small *t* together at the top, but if a very short narrow loop is sometimes made as a result of rapid movement, it will not conflict with legibility. The small *t* should always be a

little shorter than the small *l* and its companions, *b*, *h*, *k*, and *f*. The practice speed for *t* in groups of five is ten groups, or fifty letters, to the minute. There is no special value in this letter as a movement drill, but a little practice of it in group formation will be an aid to its mastery.

The Palmer Method

As you gain more control of the muscular movement, you should become more skillful in its application, and the result should be constant improvement in form, spacing, and uniformity of size. Use your eyes constantly, comparing your letters with the drills you are trying to imitate; do your best, and rapid improvement is sure to follow.

LESSON 20

After the usual practice of the compact two-space oval and the small m and n review lesson nineteen.

Drill 20

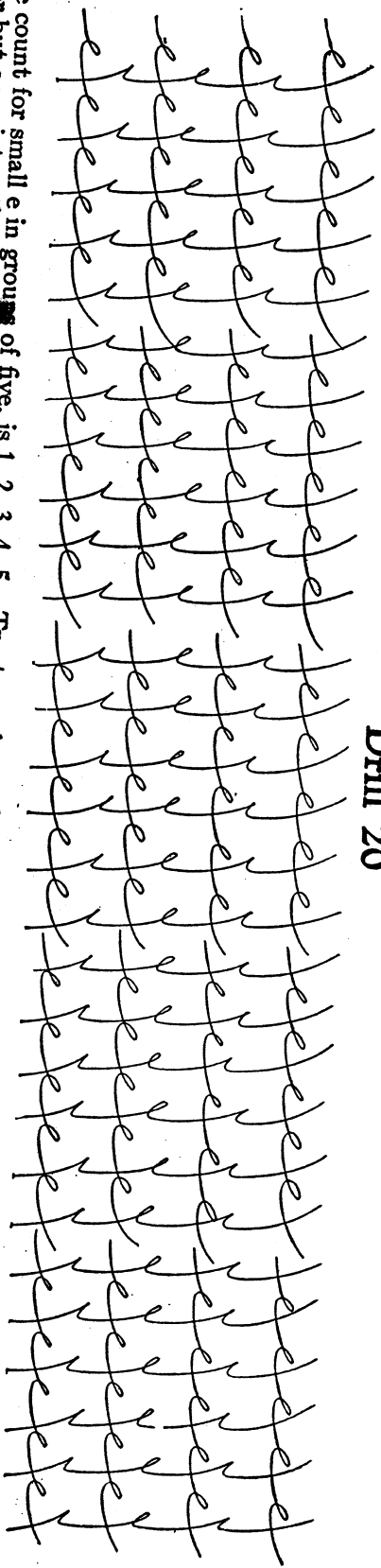

The count for small e in groups of five, is 1, 2, 3, 4, 5. Try to make the letter but one-sixteenth of an inch high. For purposes of comparison, it would be well occasionally to make rows of small o's and m's on lines close to your small e drills. The three letters should be of the same height. Making small e in groups of five, twenty-eight groups, or one hundred and forty letters, should be made in a minute.

LESSON 21—Drill 21

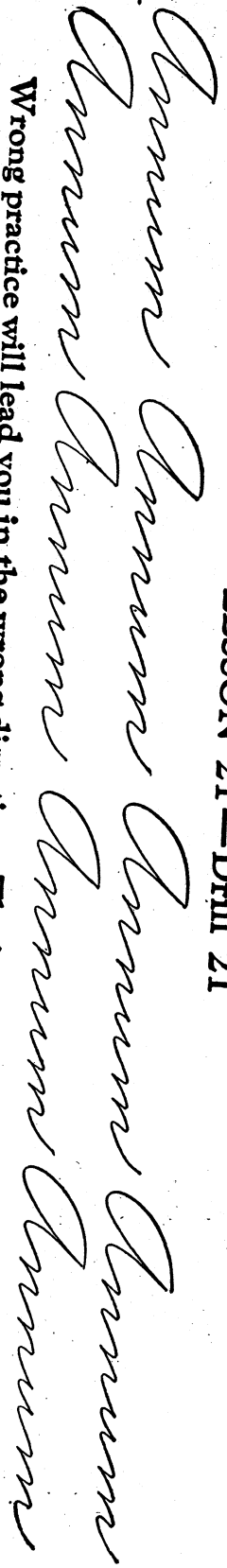

Wrong practice will lead you in the wrong direction. The instructions tell you how to practice.

Drill twenty-one is our first word drill with a capital. Do not neglect the study of the motion and its applications to form. Write fourteen or more words to a minute, and do not let them occupy more space than the copies. In writing words beginning with capital A it is better to connect the last line with the small letters following.

LESSON 22—Drill 22

Common Common Common Common
Common Common Common Common

Write fourteen words in a minute. Write a few lines and then compare your work with the drill. Review often.

LESSON 23—Drill 23

Omen Omen Omen Omen Omen
Omen Omen Omen Omen Omen

Be sure that the motion is oval in starting capital O. Trace the letter with the pen in the air. Let the pen strike the paper when moving rapidly downward. If all conditions are favorable and the movement is free, about sixteen of these should be written in a minute.

LESSON 24—Drills 24 and 25

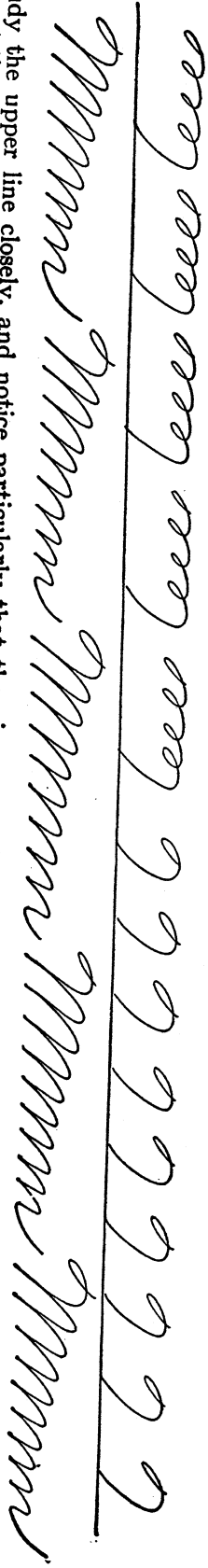

Study the upper line closely, and notice particularly that the nine exercises at the right are the enlarged form of an inverted figure six. Fix clearly in your mind the direction of the moving pen as it comes into contact with the paper in making the beginning loop. Do not make this loop larger than it is in the drill. For business writing it would be better to make a dot than a large loop. Energetic practice of the drill at the left in the first line will help to develop the right motion. In that part of the drill a count of 1, 2, 3, 4, 5, should be used. In that at the right in the first line, the count may be 1-2, down over; or down, over; or one stop for each; but each form should stop abruptly at the base line in a blunt stroke.

As this form is used for the beginning of eleven capitals, it should be thoroughly studied and practiced now, and frequently reviewed. In the lower line, observe that five drills extend across the page, with ten parts in each drill; with the paper held in the right position, the downward strokes should be made toward the center of the body, and the over-motion is applied in making the turns at the top. The count should be 1, 2, 3, 4, 5, 6, 7, 8, 9, 10, and sixteen completed exercises should be made to the minute. Turn to page twenty-nine and pick out the eleven capitals in which the inverted figure six is used. Use this style hereafter in beginning those capitals. This is a lesson that should be reviewed frequently.

LESSON 25

Drills 26 and 27

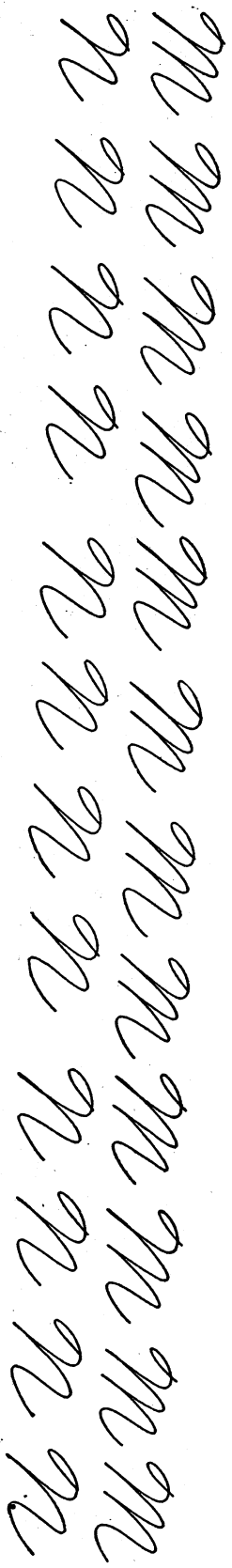

Study the capitals M and N closely before trying to make them. Compare their parts in relation to slant, height, and width. The capital M should be made in a count of 1, 2, 3, 4, at the rate of thirty a minute, and capital N in a count of 1, 2, 3, at the rate of forty a minute.

LESSON 26

Review lessons twenty-four and twenty-five.

LESSON 27

Drill 28

Moon Moon Moon Moon Moon Moon
Moon Moon Moon Moon Moon Moon

In penmanship, constant repetition is essential, and in connection with drill twenty-eight the best results will be secured by practicing the word several minutes. You are expected to write six words on a line, as in the copy, writing from fourteen to seventeen a minute.

To the Teacher: If you have studied the lessons in advance, have practiced the different drills and mastered them before giving them to

your pupils, a good plan to follow in word-practice is sometimes to sit at your desk, or a pupil's desk, writing the words with them and spelling as you write. Thus M-o-o-n, M-o-o-n. This will enable you to help your boys and girls to master the correct speed, and to secure uniform motion. Never attempt to use the count for individual letters when practicing words; it is confusing.

LESSON 28—Drill 29

Noon Noon Noon Noon Noon
Noon Noon Noon Noon Noon

Make a few lines of capital N as a movement drill before practicing the word Noon. Repeated letters and words should always be considered movement drills. Strive for a firmer, lighter motion constantly. Examine all letters and words practiced with special reference to firm, smooth

lines, their direction, size, distances between letters, height and width of the different parts, connecting lines, the finishing lines in the final letters, and every little detail. Write from fifteen to eighteen words a minute.

LESSON 29

FOR STUDY AND COMPARISON

aaaaaa aaaaaa aaaaaa
d d d d d d d d d d d d
q q q q q q q q q q q q
q q q q q q q q q q q q

Small a is, in the main, a reduced copy of capital A, and the first parts of small d, g, and q, are identical with it. Fix the resemblance in the mind; it will help you. The loop below the base line in small g should be made without finger motion. We favor the blunt style of small g and y

at the end of words, and this ending should be shorter than the loop. Fix in your mind the length of this abbreviated g. Small q is a little shorter below the base line than g. The g, ending bluntly below the base line, is just like the figure nine.

Drill 30

Handwritten practice lines for the cursive letter 'a', showing various forms and connections.

It will pay you to practice the small a drill a great deal. Try to make a half-dozen or more lines of letters as small and as uniform as the copy. Students should not forget to study the copy constantly and to make frequent comparisons of their work with it. A count of 1, 2, should

be used for each small a, and in connecting five letters it is a good plan to count 1-2, 3-4, 5-6, 7-8, 9-10. Small a in groups of five should be made at the rate of seventy a minute.

LESSON 30—Drill 31

Handwritten practice lines for the cursive letters 'd' and 'q', showing various forms and connections.

Reckoning small o, one-sixteenth of an inch high, as one space, small g should extend three spaces, or three-sixteenths of an inch below the base line while the loop of q and abbreviated g should extend two spaces below. The stem of d extends about two and one-half spaces above the base. Writing which is good in other respects is often spoiled in the written

page because the loops are too long, extending into the lines above and below. The count for each letter in groups of five should be 1-2, 3-4, 5-6, 7-8, 9-10, and the speed should be: small d, from sixty-five to seventy; g, from sixty to sixty-five, and q, about fifty to the minute.

Are you studying the instructions? They tell you just how to succeed.

he loop.
shorter
e line, is

width
final

LESSON 31—Drill 32

gadding gadding gadding gadding

Review lesson thirty before you study and practice this drill.

If you use your eyes to good advantage, you will see that the first *g* begins one space above the base line, there being no initial line starting

LESSON 32

The basis of the extended loop letters, *b, f, h,* and *k,* is small *l.* These five letters should extend the same distance above the base line. The practice of small *l* should be thorough now, and it should be reviewed often. In fact, it would be well to add it to the group of compact ovals, and small *m's* and *o's,* to be practiced at the beginning of each lesson.

Height—Reference has already been made to one-sixteenth of an inch as representing a space in height for the minimum (one-space) letters *a, c, e, i, m, n, o, u, v, w,* and *x.* The small *r* and *s* are in the same class, but are made a quarter space higher than the others.

These minimum letters should always be used as a standard of one-space measurement to regulate the height of all other small letters. On that basis small *l* should be four spaces—four-sixteenths or one-fourth of an inch high. As there are six-sixteenths of an inch between the ruled lines in the practice paper generally used, and in all the Palmer Method practice paper, there should be two-sixteenths (one-eighth) of an inch between the top of the loop and the ruled line above.

It should be remembered that a space in height is the height of the minimum letters in the style you are practicing. As an example, in copy-

from the base; also that the first parts of small *g* and *d* are of the same height as *a, o, m,* and *n,* to which special reference has already been made. Practice speed, twelve words in a minute.

books used in former years, the one-space letters were one-eighth of an inch, or twice as high as in these lessons. The loop letters were three spaces, or three-eighths of an inch high, which is two-sixteenths of an inch higher than the loops in these lessons.

Movement Used—In business writing, all loops below the line should be made with pure muscular movement. In making those above the line, the fingers should be relaxed, and as the arm slides forward, a slight extension of the fingers will help to make the upper part of the loop. The combination of the two movements is perfectly natural to most hands, and little encouragement need be given to the use of the fingers. The student must guard against using much of it. Keep an eye on your wrist to see that it moves forward and backward in unison with the other movements. Under no circumstances allow the fleshy part of the hand in front of the wrist to touch the paper.

Cautions—You will find your first difficulty in getting enough curve on the upward stroke. A half hour's determined practice will do much to overcome this. Keep the paper at such an angle as will make the downward strokes straight toward the middle of the body. Above all, preserve unity in height, in slant and in spacing. Do not shade.

Drill 33

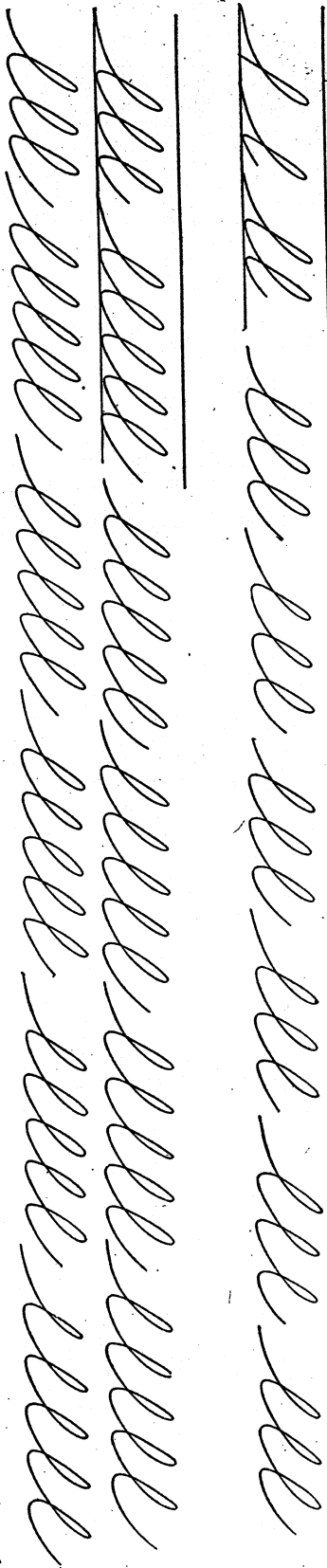

There is a slight check in the motion on the downward strokes, but no pause at the base line. After a little practice, loops as good as the above should be made at the rate of from one hundred to one hundred and twenty to the minute. The count in groups of five is, 1, 2-3, 4-5, 6-7, 8-9, 10—one for each letter.

LESSON 33—Drill 34

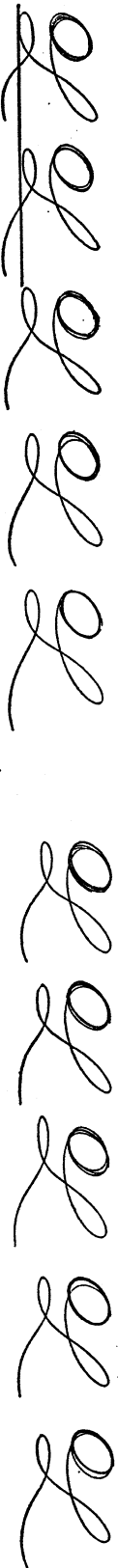

More study, more practice. Study and practice should be constant companions in developing good writing. One without the other will lead to one-sided results. Don't be one-sided.

Drill thirty-four offers good movement practice. Close observation will indicate just how it is done. The small traced oval is about one-half the capital in height, and the upper loop is also one-half the entire height of the letter. If you have a sharp eye and a responsive mind, you have been able to grasp these details without any suggestions, and

you have gone further. You have noted the curve in the main downward stroke, the flatness of the lower loop on the base line, and the dropping of the finishing stroke below the base.

Six is the count for the traced oval and three for L, as follows, 1, 2, 3, 4, 5, 6, 1, 2, 3. The count of 1, 2, 3, for the capital L should be a little slower than for the ovals. This exercise should be made ten times on a line, in groups of five, and two lines, or twenty exercises a minute.

A few minutes in the right way are worth hours of practice in the wrong way.

Drill 35



Swing for the L, swing for the L, swing for the L. In other words, study the letter closely, and swing the pen in its direction a few times before making it. The first line starts about one-half the distance from the base to the top, and dips under; the upper loop is one-half the entire length of the letter; the lower loop rests on the base line; and the finishing

line is carried below the base. This letter makes one of the best movement drills so far given. After each group of five the paper should be moved. The count is 1, 2, 3 for each letter, or slide two, three or side, L drop, or swing. L loop, From fifty to fifty-five should be made in a minute.

LESSON 34

Review lesson thirty-three.

Drill 36

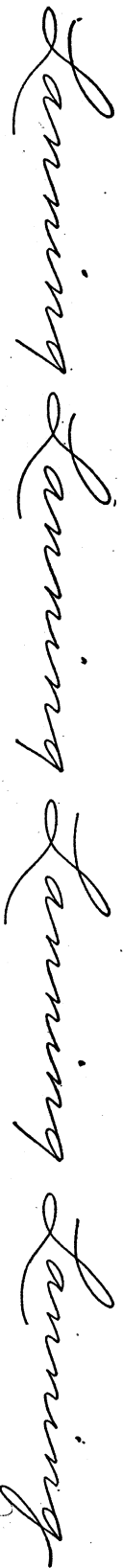

Study, practice, and compare.

Begin small a at the top just as it is in drill thirty; make the abbreviated g short below the base line, and be sure to write four words to a line. Practice speed, ten to twelve words a minute.

LESSON 35—Drill 37

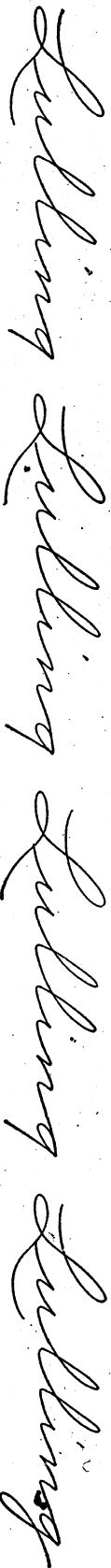

Write two lines and then make careful comparisons with the models. Are your small l's shorter than the capitals; are both l's the same height; and do they cross one space above the base? Compare slant, the parts

of letters and letters complete. Study the spacings between the letters and try to show improvement in each line. Practice speed, the same as for drill thirty-six.

You cannot fail, if you study the instructions and follow them.

LESSON 36—Drill 38

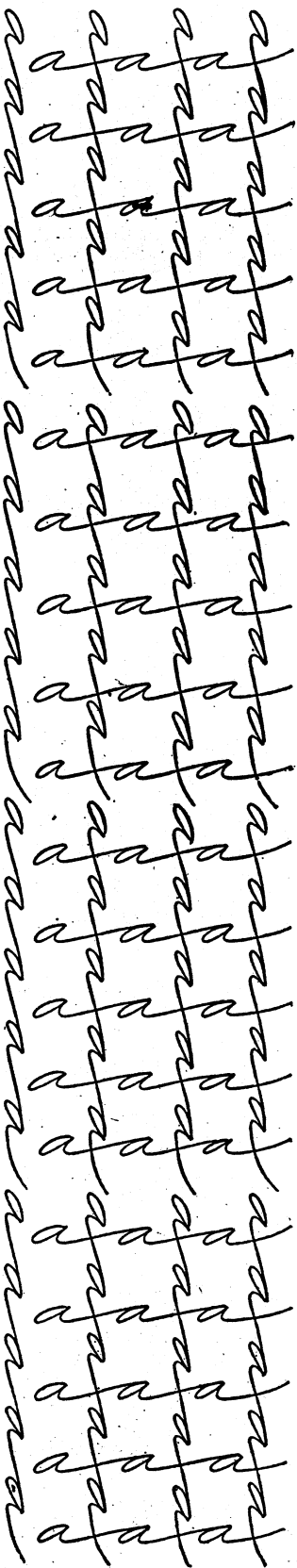

Small a should be reviewed frequently as a movement drill.

Drill 39

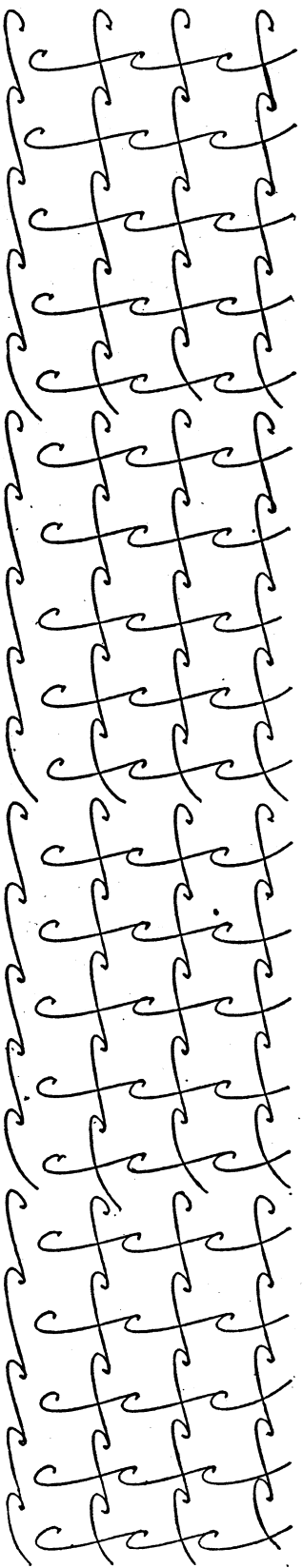

The first part of small a serves as the foundation of small c. In making connective lines, an over-motion must be used. If an under-motion is used from the ending of one c to the dot at the top of the next, there will be a loop, and the letter will be too large. After making a few lines, compare the height of c with o, a, m, and n. You will frequently compare with the copy. The count is 1-2, 3-4, 5 or dot over, dot over, dot over, dot over, dot over, for ear. The speed should be sixteen groups of five, or eighty let'

The Palmer Method

LESSON 37—Drill 40

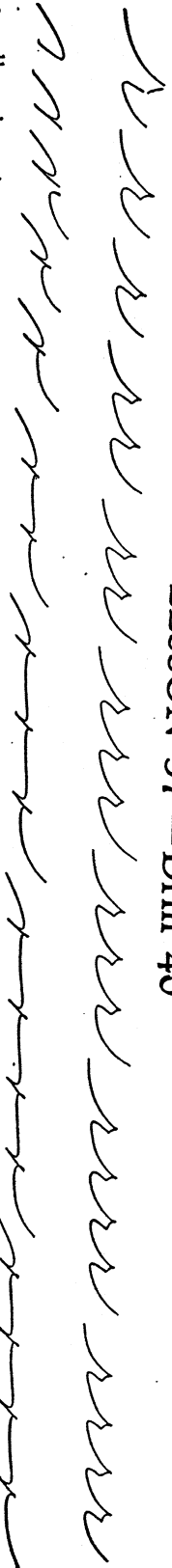

The small r given in the first line in drill forty cannot be made at a high rate of speed, as the form requires a checking of movement at the top to form the shoulder. Study the parts of the letter shown before the first completed form.

The form in the second line can be made at much higher speed, and, while somewhat difficult to learn, is much easier in execution when mastered. The first part of it is just like the first part of small m or n. The downward stroke is retraced to a point about one-fourth of a space above the first part; a stop (hardly noticeable) and a dot are made before the

swinging curve to the next letter. If the connective lines between letters of this style are made with too much under-curve, perhaps touching the base line, they will more nearly resemble small x than r. Guard against this fault.

Close study of the form while practicing will be necessary. After its mastery, ninety connected letters to the minute will be a good rate of speed. Unquestionably, the first few trials will be discouraging, but faithful practice will be rewarded. Stick to it. Eighteen groups of five should be made to the minute.

Drill 41

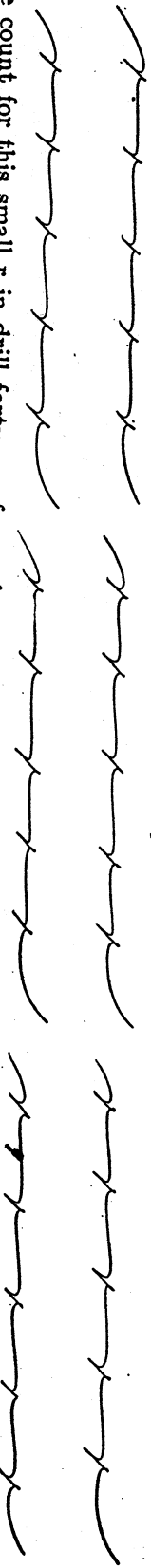

The count for this small r in drill forty-one for each group of five is 1-2, 3-4, 5-6, 7-8, 9-10; or one-dot, two-dot, three-dot, four-dot, five-dot; or one-stop, two-stop, three-stop, four-stop, five-stop. A conversational count similar to that in small o, drill eleven, may be used

to advantage in small r, thus—You-stop, you-stop, you-stop, you-stop, at-the-top. How long, do you stop, at the top? Not long, but you stop, every time at the top. What for, what for, what for? To make a dot, to make a dot, to make a dot, etc.

Drill 42

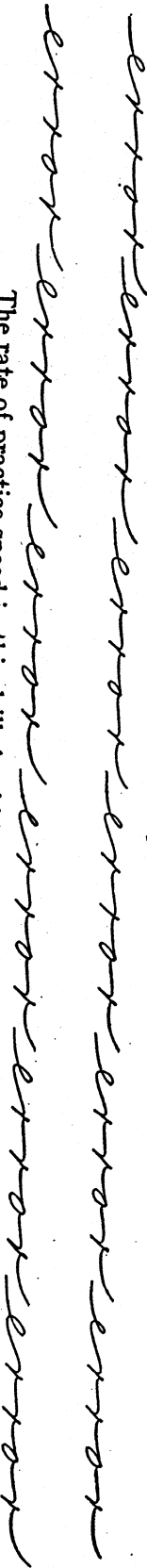

The rate of practice speed in this drill should be twenty or more words to the minute.

Drill 43

occur occur occur occur occur

There is no initial line before small o; it begins at the top.

LESSON 38

As before mentioned, small r and s are companion letters, and both at the top, and entirely closed on the base line. Be sure to use just the may be made one-fourth higher than other letters of the minimum class; right amount of under-curve in the beginning stroke, and the width will not because of any technical rule, but rather because it generally is agreed depend upon the amount of curve in the last part. Practice, study, and that they look better so made. Small s should be pointed, not looped, compare.

Drill 44

*Period. Question Marks? Comma,
Exclamation Point! Colon: Semicolon;
The Dash - Quotation Marks " " And x
Parenthesis () Hyphen - Care of %*

Punctuation Marks

The punctuation marks are printed here so that pupils may study

them early and often until they are familiar with them and know how to make them.

THE FREQUENCY OF REVIEWS

To Teachers: Assuming that teachers of the Palmer Method master the lessons in their order before attempting to teach them, they are to decide when lessons and drills have not been mastered and need

reviewing. Without knowing the pupils or seeing their daily work in penmanship, it would hardly be possible for us to advise with unerring accuracy when they should review.

LESSON 44—Drill 45



The first two parts of small w form u. As explained in lesson nineteen, the distance between the points in small u represents a lateral (running) space. Keeping this space in mind, carry the third or finishing part of small w one-half space to the right of the second, or finishing point

in small u. The connecting stroke is slightly curved. Eighteen or twenty groups of three should be made to the minute and the count for each letter is 1, 2, 3; 1, 2, 3; 1, 2, 3; 1, 2, 3 or one, two, dot; one, two, dot; one, two, dot.

Drill 46

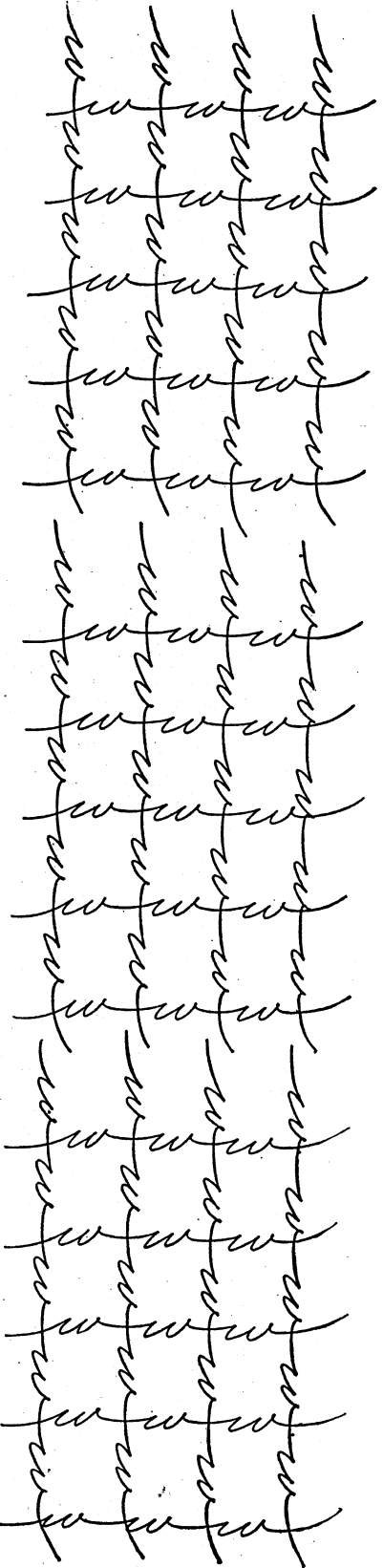

LESSON 45—Drill 47

Small x is simple in construction. Study closely before practicing it. The crossing may be made either upward or downward. In writing a word containing it, complete the word before crossing the letter. Make the crossing short.

Handwritten practice for the letter 'v' in cursive, showing multiple strokes across several lines.

Drill 48

lined lined lined lined lined

LESSON 46—Drill 49

Handwritten practice for the letter 'w' in cursive, showing multiple strokes across several lines.

The first part of small v is the same as the first part of small x, and it is ended with the form used in finishing small w. Don't close this letter at the top. It must be left open. Count 1-2, 3-4, 5-6, 7-8, 9-10, for each group of five letters.

Drill 50

wave wave wave wave wave

LESSON 47—Drill 51

The loop in h is small l, brought to the base in a straight line on the main slant, the second part is one section of small m. Notice that the first and last parts of small h meet on the base in a point. Study until you see just how it is done.

A count of 1-2, should be used for one h, and a count of 1-2, 3-4, 5-6,

Drill 52

LESSON 48

Review lessons forty-seven and forty-eight, and then give attention to the following.

Drill 53

The practice speed should be twenty or more of the first two words and sixteen or more of the third word to the minute. Guard against making h higher than l. All loop letters above the base should be the same length.

LESSON 49

THE REVERSE OVAL AND ITS APPLICATION

An application of the reverse oval motion is made in forming capital J. The reverse oval, it must be understood, begins with an upward stroke on the left side. Before attempting capital J, make reverse ovals

four or five minutes, and if the movement is then light and uniform, the copy may be safely practiced. The oval is used as the developing and driving force.

Drill 54



Make the oval to a count of six, lift the pen from the paper at the top, and without checking the motion swing the pen in its natural course above the paper, to the right and below the base to the point of contact with the paper in starting the letter. Do not stop the motion, but strike the paper in an upward course at full speed for the beginning stroke of J. If the explanation of applied motion is not fully

understood, study until it is, and then fill at least a half page with the copy. Do not neglect the form, but note carefully the following points: I should begin with an upward stroke from a point just below the base line; the turn at the top should be round; the upper part should be a little longer than the lower part, and twice its width.

LESSON 50—Drill 55



If slant is troublesome, study and practice this drill faithfully. Count 1, 2, 3 for capital J and make sixty to seventy letters to a minute.

Drill 56



This copy is given as a drill on both movement and form. From the beginning stroke of J to the finishing of small s the pen should not be lifted. Write the word from beginning to end with a steady, light and uniform movement. Eighteen or twenty words to the minute will be a fair rate of speed for practice.